

FLOS

09.4288.14 Black

UT Spot Track Ø 86

Designed by FLOS Architectural, 2015



Spotlight to be installed on 3-phase track. with LED light source. 220-240V, 50-60Hz power supply integrated.

Are you a professional and your project needs consulting and support?

[BOOK AN APPOINTMENT](#)

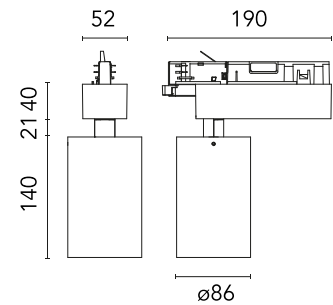

Main specifications

Mounting	Track
Environments	Indoor dry location
Light Source Type	LED
LED type	Phosphor LED
Lamp category	LED
Iicos	No
Bulb finish	Clear
Number of heads	1
Power (W)	34.1
System power (W)	34.1
Source flux (lm)	3000
System flux (lm)	1654

Physical

Colour	Black
Trim	No
Orientation	Adjustable
Rotation (°)	360
Longitudinal tilting (°)	90
Spot diameter (mm)	86
Net weight (kg)	1.36
IP internal	20
IP external	20

Download

[Mounting instructions](#)  ZIP

Photometric Files

[LDT / IES](#)  ZIP

Technical Drawings

[2D](#)  ZIP

[3D](#)  ZIP

[Bim](#)  ZIP



Schematic light drawing

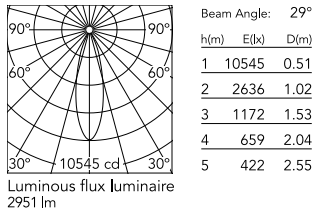

Photometric

Lighting type	Direct
Light distribution	Symmetric
CCT (K)	3000
CRI>	98
Beam angle C0-180 (°)	32
Beam angle C90-270 (°)	32

Electrical

Insulation class	II
Frequency (Hz)	50/60
Main voltage (Vac)	220-240V
Alternating current voltage (Vac)	230
LED current (mA)	1050
Driver	Integrated
Dimmable	No
Dimming type	Non Dimmable
Dimming interface	Not Dimmable
Emergency type	No

Notes

FLOS three-phase lighting track luminaires are designed and fully tested for tracks recommended by FLOS. Compatibility is guaranteed with three-phase track produced by Nordic Aluminium. Compatibility with Eutrac under request.

Ecodesign and Energy Labelling



Replaceable (LED only) light source by a professional



Replaceable control gear by a professional

Accessories & Power Supply



OPTIONAL
Accessory

Optical

08.8411.00

Screening crosspiece