

FLOS

F6602009 Matte White

Taccia

Designed by Achille and Pier Giacomo Castiglioni, 1962



28W - 2700K

Table lamp providing indirect and reflected light. Reflector in painted aluminium, gloss white on the outside and matt white on the inside. Directionable diffuser in transparent mouth-blown glass. Body in black, matt white, silver anodized or bronze anodized aluminium. Base in nickel-plated metal. Electric cable of useful length 220 cm, with dimmer switch for ON/OFF and adjustment of the light flow between 10-100%. Plug-in power supply with interchangeable plugs.

Are you a professional and your project needs consulting and support?

BOOK AN APPOINTMENT

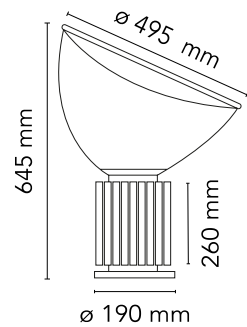

Main specifications

EAN	8059607058978
Mounting	Table floor
Environments	Indoor dry location
Light Source Type	LED
LED type	LED array
Power (W)	28

Physical

Colour	Matte White
Length (mm)	190
Cord colour	White
Cord length (mm)	2200
Net weight (kg)	10.74
Package volume (m3)	0.18
IP internal	20

Download

- Mounting instructions PDF
- Mounting instructions PDF

Ecodesign and Energy Labelling

This product contains a light source of energy efficiency class D

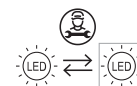

Replaceable (LED only) light source by a professional

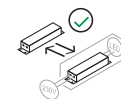

Replaceable control gear by an end-user

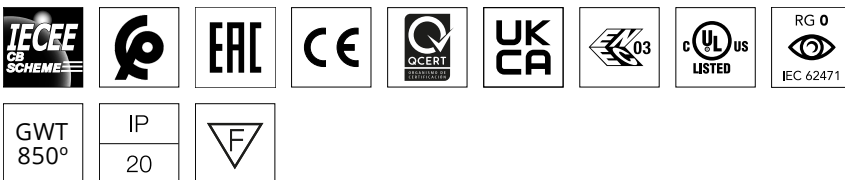

Photometric

Lighting type	Indirect
Light distribution	Asymmetric
CCT (K)	2700
Extreme cut off	No

Electrical

Insulation class	III
Frequency (Hz)	50/60
Main voltage (Vac)	100-240/48
Power Supply	Remote included
Power Supply Type	Electronic 48V
Plug type	Type G, Type A, Type C
Batteries inside	No

Spare Parts

