

FLOS

F004E21A033 Anthracite

Landlord Spot Ø50 PWM Dimmable Anthracite

Designed by Piero Lissoni



Spot adjustable head for installation on ground poles or on wall base. Poles and base to be ordered as separated accessories. Heads are equipped with a dismountable ferrule, to insert flood lens or up to two honeycombs, (to be ordered as separate accessories). 24V remote power supply to be ordered separately. Each head comes with a 2000 mm length outgoing cable and a wiring kit.

Are you a professional and your project needs consulting and support?

BOOK AN APPOINTMENT

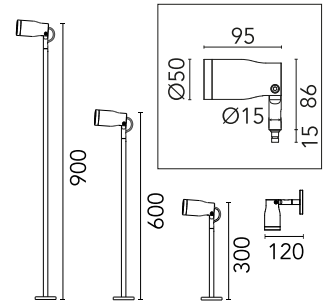

Main specifications

Mounting	Wall, Ground
Environments	Outdoor wet location
LED type	Power LED
Lamp category	LED
Iicos	No
Power (W)	3.40
System flux (lm)	135

Physical

Colour	Anthracite
Trim	No
Orientation	Adjustable
Rotation (°)	359
Transversal tilting (°)	120
Net weight (kg)	0.35
IP internal	66

Download

Mounting instructions [ZIP](#)

Photometric Files

LDT / IES [ZIP](#)

Technical Drawings

2D [ZIP](#)

3D [ZIP](#)

[Bim](#) [ZIP](#)



Schematic light drawing

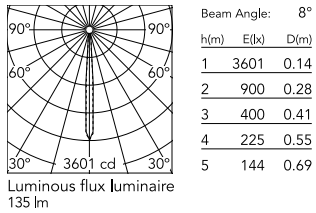

Ecodesign and Energy Labelling

This product contains a light source of energy efficiency class E



Replaceable (LED only)
light source by a
professional

Photometric

Lighting type	Direct
Light distribution	Symmetric
CCT (K)	2700
CRI>	80
Beam angle C0-180 (°)	7
Beam angle C90-270 (°)	7

Electrical

Insulation class	III
Frequency (Hz)	50-60
Main voltage (Vac)	24
Driver	Remote excluded
Dimmable	Yes
Dimming type	Non Dimmable, Dimmable 1-10 PWM, Dimmable DALI 1 PWM
Emergency type	No

Notes

During the installation and the maintenance of the fixtures it is important to be careful and avoid damages on the paint coating.

Damages on the coating exposed to outdoor conditions or water, could cause corrosion.

Chemical substances affect the anticorrosion covering protection.

For LED fixtures, there is evidence that most of the damages are connected to electrical effects related to the insulations, which cause destructive electrical discharges

These effects are frequently caused by:

- over voltage coming from the mains' network where fixture is connected.
- electrostatic discharge (ESD) coming from the environment.

The use of a protective device against the overvoltage on the electrical installation is warmly suggest this helps to reduce the intensity of some of these phenomenon and prevent irreversible damages. The selection of the type of device to be used must be adjust on the electrical plant.

Accessories & Power Supply



REQUIRED
Power supply

RF25754

Power supply dual function Vout
24Vdc: 8W/100÷240V Iout
350ma: 6x1W/100÷240V IP20
Class II selv_Non Dimmable



REQUIRED
Power supply

RF25757

Power supply 24V 10W / 110-
240V IP67 Class II selv_Non
Dimmable



REQUIRED
Accessory

F004Z040033

Wall base Anthracite



REQUIRED
Accessory

F004Z030033

Pole with base H 900 mm
Anthracite



REQUIRED
Accessory

F004Z020033

Pole with base H 600 mm
Anthracite



REQUIRED
Accessory

F004Z010033

Pole with base H 300 mm
Anthracite



REQUIRED
Power supply

RF25747

Power supply 24V 10W /110-
240V IP20 Class II selv. Non
Dimmable



REQUIRED
Power supply

RF25748

Power supply dual function Vout
24Vdc: 8W/100÷240V Iout
350ma: 6x1W/100÷240V IP65
Class II selv. Non Dimmable



REQUIRED
Power supply

F990B00A000
CONTROL INTERFACE 24V PWM -
1..10V IP67 CLASS III. VIN 24Vdc
120W (POWER SUPPLY NOT
INCLUDED)



REQUIRED
Power supply

F990B04A000
POWER SUPPLY 24V PWM WITH
1..10V CONTROL INTERFACE
IP67 CLASS II. Vin 120-270Vac
70W



REQUIRED
Power supply

F990B02A000
POWER SUPPLY 24V PWM WITH
1..10V CONTROL INTERFACE
IP67 CLASS II. Vin 120-270Vac
35W



REQUIRED
Power supply

F990B03A000
POWER SUPPLY 24V PWM WITH
DALI CONTROL INTERFACE IP67
CLASS II. Vin 120-270Vac 35W



REQUIRED
Power supply

F990B01A000
CONTROL INTERFACE 24V PWM -
DALI IP67 CLASS III. Vin 24Vdc
120W (POWER SUPPLY NOT
INCLUDED)



REQUIRED
Power supply

F990B05A000
POWER SUPPLY 24V PWM WITH
DALI CONTROL INTERFACE IP67
CLASS II. Vin 120-270Vac 70W



REQUIRED
Power supply

F990B23AZ00
Power supply 24Vdc 35W /120-
270V IP67 Class II selv.



REQUIRED
Power supply

F990B16A000
POWER SUPPLY 24V PWM WITH
PUSH CONTROL INTERFACE IP67
CLASS II. Vin 120-270Vac 35W



REQUIRED
Power supply

F990B17A000

POWER SUPPLY 24V PWM WITH
PUSH CONTROL INTERFACE IP67
CLASS II. Vin 120-270Vac 70W



REQUIRED
Power supply

F990B27A000

Power supply 24Vdc 70W / 220-
240V IP67 Class I selv. Non
Dimmable



REQUIRED
Power supply

F990B28A000

Power supply 24Vdc 50W / 220-
240V IP67 Class I selv. Non
Dimmable



OPTIONAL
Accessory

F990C00A000

2 way terminal block 4 poles IP68
H2O stop. (ø5,5÷12mm cable)



OPTIONAL
Accessory

F990C010000

3/4 way terminal block 4 poles
IP68 H2O stop. (ø5,5÷12mm
cable)



OPTIONAL
Accessory

F004Z0L0000

Honeycomb



OPTIONAL
Accessory

F004Z0H0000

Flood lens



OPTIONAL
Accessory

F004Z070000

Tree strap



OPTIONAL
Accessory

F004Z060000

Earth stick