

FLOS

06.5152.14 Black

Data Connection Rod Rose Ø 50 mm

Designed by Vincent Van Duysen, 2018



Data connection rod rose ø50mm. Use one for each line of the installation, for connection to DALI or 1-10V signal source. Adjustable 25 mm, to adapt it to irregular ceilings.

Are you a professional and your project needs consulting and support?

[BOOK AN APPOINTMENT](#)

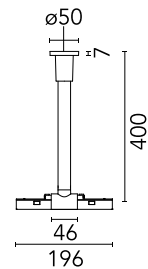

Main specifications

Mounting	Ceiling surface
Environments	Indoor dry location
Iicos	No

Physical

Colour	Black
Trim	No
Length (mm)	400
Net weight (kg)	0.60
IP internal	20
IP external	20

Download

[Mounting instructions](#)

[↓ PDF](#)



Electrical

Driver	Remote excluded
Dimming type	Non Dimmable, Dimmable 1-10V, Dimmable DALI 1
Emergency type	No

Notes

The closure terminals will also be electrified and must be ordered separately. Data connection rod rose $\varnothing 50$ mm: Use one for each line of the installation, for connection to DALI or 1-10V signal source. Adjustable 25 mm, to adapt it to irregular ceilings.

Accessories & Power Supply



REQUIRED
Power supply

Electrical

60.8919

LED Power Supply Source for remote installation. 48V/320W. 100/240 Vac



REQUIRED
Power supply

Electrical

60.9170

LED power supply source for remote installation, 48V/120W. 220/240 Vac



REQUIRED
Power supply

Electrical

60.9607

LED power supply source for remote installation, 110Vac-135W / 220Vac-200W.



REQUIRED
Component

06.5135.14A

End Cap Dali/1-10V/FLOS Control® by Casambi compatible



REQUIRED
Component

06.5135.40A

End Cap Dali/1-10V/FLOS Control® by Casambi compatible



REQUIRED
Component

06.5142.14A

End Cap On board dimmer/FLOS Control® by Casambi compatible



REQUIRED
Component

06.5142.40A

End Cap On board dimmer/FLOS Control® by Casambi compatible

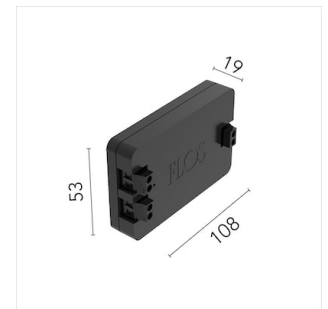

OPTIONAL
Power supply

Electrical

08.0613.14A

Dimmable control box 1-10V, 48V. For remote installation.