

# FLOS

F1595023 Dark Grey/Olive Green

## Chiara Table

LED retrofit - 10W



Table lamp composed of a reflecting body in aluminium in 3 colour variations, finished internally with an opaque white plastic film and folded and closed via hooks riveted to the sheet metal. A coloured seal in moulded tpu runs along the entire profile of the body. The internal base in extruded aluminium is attached to the body for stability and it also supports the bulb socket. The power cable has a dimmer switch to adjust the brightness. Usable cable length: 1.9 m

Are you a professional and your project needs consulting and support?

[BOOK AN APPOINTMENT](#)

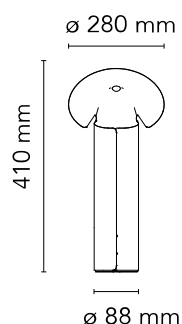

### Main specifications

|                   |                     |
|-------------------|---------------------|
| EAN               | 8059607032312       |
| Mounting          | Table               |
| Environments      | Indoor dry location |
| Light Source Type | Bulb                |
| Lamp category     | LED retrofit        |
| Lamp holders      | E14                 |
| Ilcos             | HSGS                |
| Number of heads   | 1                   |
| Power (W)         | 10                  |

### Physical

|                     |                       |
|---------------------|-----------------------|
| Colour              | Dark Grey/Olive Green |
| Cord length (mm)    | 1900                  |
| Net weight (kg)     | 1.32                  |
| Package volume (m3) | 0.06                  |
| IP internal         | 20                    |

### Download

[Mounting instructions](#)  PDF

[Spare Parts](#)  PDF

### Photometric Files

[LDT / IES](#)  LDT



## Schematic light drawing

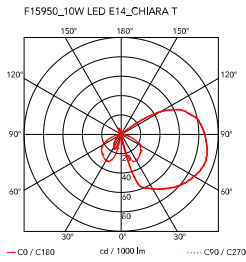

## Photometric

|                    |            |
|--------------------|------------|
| Lighting type      | Indirect   |
| Light distribution | Asymmetric |

## Electrical

|                      |                   |
|----------------------|-------------------|
| Insulation class     | II                |
| Frequency (Hz)       | 50/60             |
| Main voltage (Vac)   | 100-240           |
| LED voltage Vf (Vdc) | null              |
| Dimmable             | Yes               |
| Dimming interface    | Dimmer Integrated |
| Plug type            | Type C            |
| Batteries inside     | No                |

## Bulbs

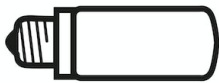

NOT INCLUDED

RF32290

LED Lamp E14 8W 2700K T28

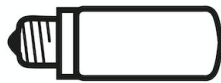

NOT INCLUDED

RF32291

LED Lamp E14 8W 3000K T28



NOT INCLUDED

RF32767

LED Lamp 9W E14 220-240V  
2700K T28

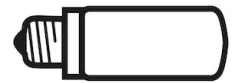

NOT INCLUDED

RF32768

LED Lamp 9W E14 220-240V  
3000K T28

## Spare Parts

01. Black Dimmer Switch

RF28206

**DOWNLOAD**

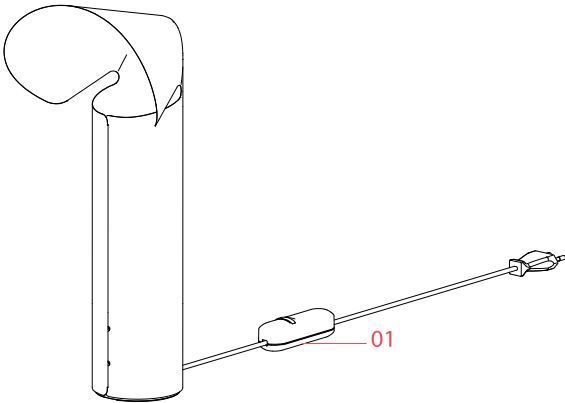



RF28206

Black Dimmer Switch