

FLOS

F1081026 Cioko

Bellhop Glass S2

Designed by Edward Barber and Jay Osgerby, 2025



LED retrofit - 30W

Bellhop Glass Suspension can be used as an ambient light but also as a task light, which directly illuminates, with a non-blinding cone of light, the surface on which it is suspended. The hole in the bottom part of the lamp, protected by an aluminum element, is shaped to direct the light (and change the bulb) avoiding the diffusion up to the eyes of those sitting at the table. A cone of light is therefore created inside the suspended Bellhop Glass, which expands homogeneously in the environment on all sides and lands on the table precisely, like a torch, visually signaled by the colored aluminum ring that surrounds the lower opening of the lamp.

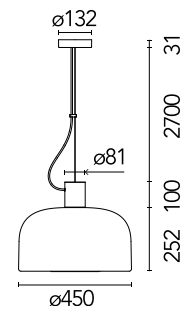

Are you a professional and your project needs consulting and support?

[BOOK AN APPOINTMENT](#)

Main specifications

EAN	8059607068670
Mounting	Suspension
Environments	Indoor dry location
Light source type	Bulb
Light sources included	No
Lamp category	LED retrofit
Lamp holders	E27
Icos	HSGSA
Number of lamps	1
Power (W)	30
System power (W)	30

Physical

Colour	Cioko
Orientation	Fixed
Length (mm)	450
Cord colour	Grey
Cord length (mm)	2700
Canopy colour	Cioko
Canopy length/diameter (mm)	132
Canopy height (mm)	31
Net weight (kg)	7.2
Package volume (m3)	0.14
IP internal	20

Download

[Mounting instructions](#)  PDF

Photometric Files

[LDT / IES](#)  ZIP

Technical Drawings

[2D](#)  ZIP

[3D](#)  ZIP

Ecodesign and Energy Labelling



Replaceable (LED only) light source by an end-user



Schematic light drawing

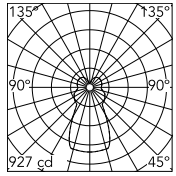

Beam Angle: - 60°

h(m)	E(lx)	D(m)
1	927	1.15
2	232	2.30
3	103	3.45
4	58	4.60
5	37	5.75

Luminous flux luminaire
3660 lm

Photometric

Lighting type	Total
Light distribution	Symmetric
Extreme cut off	No

Electrical

Insulation class	I
Frequency (Hz)	50/60
Main voltage (Vac)	220-240
Dimmable	Yes
Dimming interface	Remote Dimmable (Dimmer Not Included)
Batteries inside	No

Bulbs

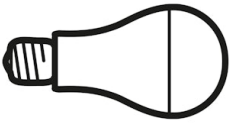

NOT INCLUDED

RF36503

LED 25W E27 3700lm 2700K

240° DIMMER

Spare Parts

- 02. Steel cable 3 meters RF36887
- 04. Bellhop Glass S2 white diffuser F1083026
brown ring

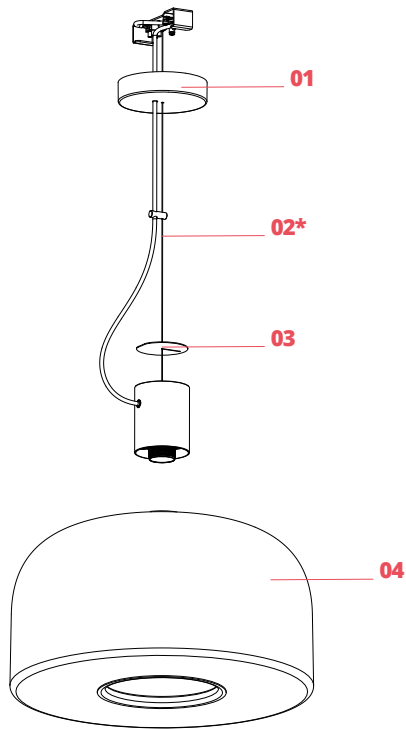

***To be replaced only by authorised service centres or qualified professionals.**

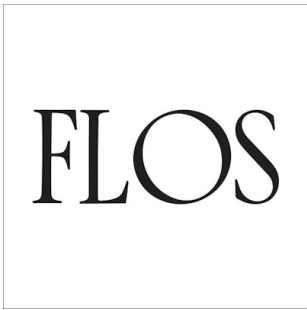

RF36887

Steel cable 3 meters

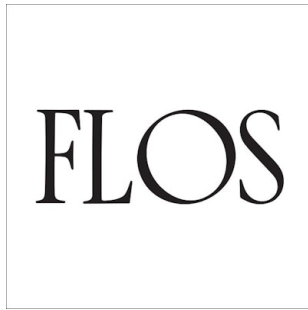

F1083026

Bellhop Glass S2 white diffuser
brown ring