

FLOS

 F1070075 Brick Red

Bellhop Floor

Designed by Edward Barber and Jay Osgerby, 2020

26W - 1023lm - 2700K - CRI> 90



Floor lamp with indirect light. Stem in painted aluminium: shiny white, brick, cioko, green. Reflector in shiny opal white and grey blown glass. Electrical cable of 270 cm usable length with foot dimmer switch for ON/OFF function and brightness adjustment 10–100%. Power supply with interchangeable plugs.

Are you a professional and your project needs consulting and support?

[BOOK AN APPOINTMENT](#)

Main specifications



| | |
|-------------------|---------------------|
| EAN | 8059607039717 |
| Mounting | Floor |
| Environments | Indoor dry location |
| Light Source Type | LED |
| LED type | LED array |
| Power (W) | 26 |
| System power (W) | 26 |
| System flux (lm) | 1023 |

Physical

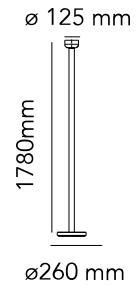
| | |
|---------------------|-----------|
| Colour | Brick Red |
| Length (mm) | 260 |
| Cord length (mm) | 2700 |
| Net weight (kg) | 9.82 |
| Package volume (m3) | 0.05 |
| IP internal | 20 |



Download

- [Mounting instructions](#)  PDF
- [Mounting instructions](#)  PDF
- [Spare Parts](#)  PDF

Photometric Files

- [LDT / IES](#)  LDT

Technical Drawings

- [3D](#)  ZIP
- [Bim](#)  ZIP



Schematic light drawing

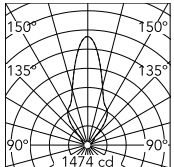

Beam Angle: 33°

| h(m) | E(lx) | D(m) |
|------|-------|------|
| 1 | 1474 | 0.59 |
| 2 | 368 | 1.19 |
| 3 | 164 | 1.78 |
| 4 | 92 | 2.38 |
| 5 | 59 | 2.97 |

Luminous flux Luminaire
1232 lm

Photometric

| | |
|--------------------|----------------|
| Lighting type | Indirect |
| Light distribution | Roto symmetric |
| CCT (K) | 2700 |
| CRI> | 90 |

Electrical

| | |
|----------------------|--|
| Insulation class | III |
| Frequency (Hz) | 50/60 |
| Main voltage (Vac) | 100-240/48 |
| LED voltage Vf (Vdc) | null |
| LED current (mA) | 700 |
| Driver | Remote included |
| Dimmable | Yes |
| Dimming type | Electronic 48V |
| Dimming interface | Switch Integrated (Remote Dimmable) |
| Plug type | Type G, Type A, Type C |
| Batteries inside | No |

Ecodesign and Energy Labelling

This product contains a light source of energy efficiency class **G**



Replaceable (LED only)
light source by a
professional

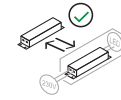

Replaceable control
gear by an end-user

Spare Parts

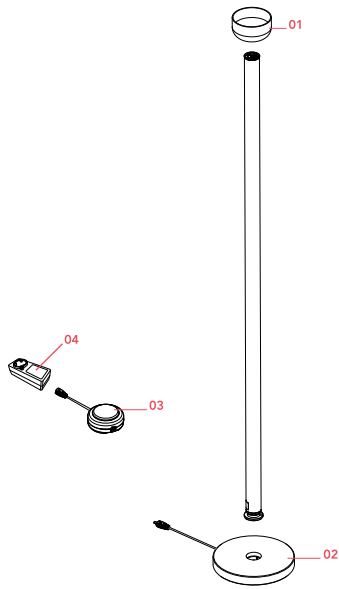

04. Black plug assembly kit & 48V
driver

RF3320400

DOWNLOAD



RF3320400

Black plug assembly kit & 48V
driver