

FLOS

09.4851.14CDA Black

UT Spot Track Ø 86 Dali Version

Designed by FLOS Architectural, 2017



Spotlight to be installed on 3-phase track. with LED light source. 220-240V, 50-60Hz power supply integrated.

Are you a professional and your project needs consulting and support?

[BOOK AN APPOINTMENT](#)

Main specifications

Mounting	Track
Environments	Indoor dry location
Light source type	LED
Light sources included	Yes
LED type	LED array
Lamp category	LED
Number of lamps	1
Power (W)	27.8
System power (W)	32.1
Source flux (lm)	3506
Lumen Output (lm)	2176

Physical

Colour	Black
Trim	No
Orientation	Adjustable
Rotation (°)	360
Longitudinal tilting (°)	90
Spot diameter (mm)	86
Net weight (kg)	0.74
IP internal	20

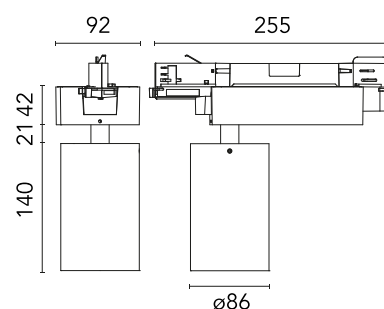

Download

[Mounting instructions](#) PDF

[Mounting instructions](#) PDF

Photometric Files

[LDT / IES](#) ZIP

Technical Drawings

[2D](#) ZIP

[3D](#) ZIP



Schematic light drawing

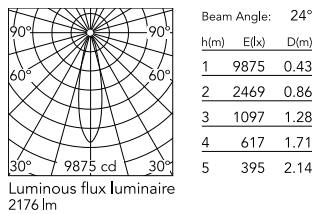

Photometric

Lighting type	Direct
Light distribution	Symmetric
CCT (K)	4000
CRI>	90
Beam angle C0-180 (°)	24
Beam angle C90-270 (°)	24
Extreme cut off	No
UGR _L	<10

Electrical

Insulation class	II
Frequency (Hz)	50/60
Main voltage (Vac)	220-240
Power supply	Integrated
Dimmable	Yes
Power supply type	Dimmable DALI 1
Dimming interface	Remote Dimmable (Dimmer Not Included)

Ecodesign and Energy Labelling

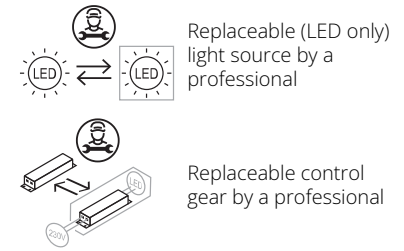

Notes

FLOS three-phase lighting track luminaires are designed and fully tested for tracks recommended by FLOS. Compatibility is guaranteed with three-phase track produced by Nordic Aluminium. Compatibility with Eutrac under request. FLOS three-phase DALI track luminaires are designed for Pulse DALI from Nordic Aluminium.

Accessories & Power Supply



OPTIONAL
Accessory

Optical

08.8410.00

Holding ring



OPTIONAL
Accessory

Optical

08.8411.00

Screening crosspiece



OPTIONAL
Accessory

Optical

08.8163.68

Elliptical lens



OPTIONAL
Accessory

Optical

08.8175.68

Flood lens



OPTIONAL
Accessory

Optical

08.8495.14

Honeycomb