

FLOS

F021B13D012 Forest Green

Outgraze 50 L 900 mm Dimmable DALI Forest Green

Designed by FLOS Outdoor, 2019



Integrated 120/240V power supply. Installation brackets, to be ordered separately.
Extra clear transparent glass, excluding the DIFFUSE version with sandblasted glass.
SMART dimmable DALI version available upon request (power 11W - flux -50% lm). 1-10V dimmable version upon request.

Are you a professional and your project needs consulting and support?

[BOOK AN APPOINTMENT](#)

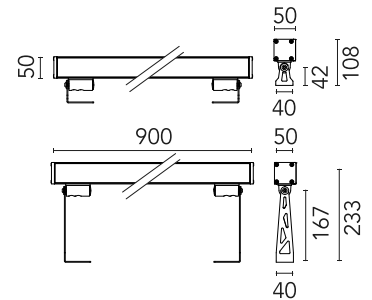

Main specifications

EAN	8054793345765
Mounting	Wall
Environments	Outdoor wet location
Light source type	LED
Light sources included	Yes
LED type	Power LED
Number of lamps	1
Power (W)	20
System power (W)	20
Lumen Output (lm)	1971

Physical

Colour	Forest Green
Trim	No
Orientation	Adjustable
Transversal tilting (°)	180
Length (mm)	900
Net weight (kg)	2.47
Package height (mm)	130
Package width (mm)	120
Package length (mm)	970
Package volume (m3)	0.02
IP internal	66
Drive Over	No

Download

Mounting instructions [ZIP](#)

Photometric Files

LDT / IES [ZIP](#)

Technical Drawings

2D [ZIP](#)

3D [ZIP](#)

Ecodesign and Energy Labelling

Replaceable (LED only) light source by a professional

Replaceable control gear by a professional



Schematic light drawing

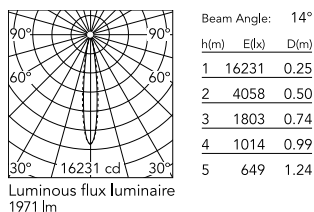

Photometric

Lighting type	Direct
Light distribution	Symmetric
CCT (K)	2200
CRI>	80
Beam angle C0-180 (°)	13
Beam angle C90-270 (°)	13
Extreme cut off	No

Electrical

Insulation class	I
Frequency (Hz)	50/60
Main voltage (Vac)	220-240
Power supply	Integrated
Dimmable	Yes
Power supply type	Dimmable DALI 2
Dimming interface	Dimmer Integrated
Emergency	No

Notes

We recommend using a connection system with a degree of protection greater than or equal to the degree of protection of the luminaire.

During the installation and the maintenance of the fixtures it is important to be careful and avoid damages on the paint coating.

Damages on the coating exposed to outdoor conditions or water, could cause corrosion.

Chemical substances affect the anticorrosion covering protection.

For LED fixtures, there is evidence that most of the damages are connected to electrical effects related to the insulations, which cause destructive electrical discharges

These effects are frequently caused by:

- over voltage coming from the mains' network where fixture is connected.
- electrostatic discharge (ESD) coming from the environment.

The use of a protective device against the overvoltage on the electrical installation is warmly suggest this helps to reduce the intensity of some of these phenomenon and prevent irreversible damages. The selection of the type of device to be used must be adjust on the electrical plant.

Accessories & Power Supply



REQUIRED
Accessory

F021Z040000

Plug&play connector 5 poles



REQUIRED
Accessory

F021Z060000

5-pole plug&play connector + 5-pole cable, 5000 mm length.



REQUIRED
Accessory

F1203012

One pair of short brackets L 80 mm. Forest Green



REQUIRED
Accessory

F1204012

One pair of long brackets L 200 mm. Forest Green



REQUIRED
Accessory

F990C030000

4 way junction box 5 poles IP68 (6-14 mm cables)