

FLOS

■ F020J2KH030 Black

Outgraze 35 Easy L 600 mm Black

Designed by FLOS Outdoor, 2019



24V remote power supply and installation brackets to be ordered separately.
Dimmable PWM luminaires. Sandblasted glass.

Are you a professional and your project needs consulting and support?

[BOOK AN APPOINTMENT](#)

Main specifications

EAN	8054793339542
Mounting	Wall
Environments	Outdoor wet location
Light source type	LED
Light sources included	Yes
LED type	Top LED
Number of lamps	1
Power (W)	9
System power (W)	9
Lumen Output (lm)	381

Physical

Colour	Black
Trim	No
Orientation	Adjustable
Transversal tilting (°)	180
Length (mm)	600
Net weight (kg)	1.38
Package height (mm)	665
Package width (mm)	120
Package length (mm)	125
Package volume (m3)	0.01
IP internal	66
Drive Over	No

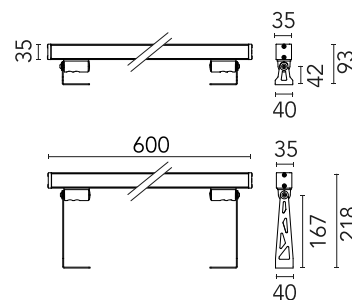

Download

[Mounting instructions](#) ZIP

Photometric Files

[LDT / IES](#) ZIP

Technical Drawings

[2D](#) ZIP

[3D](#) ZIP

[Bim](#) ZIP



Schematic light drawing

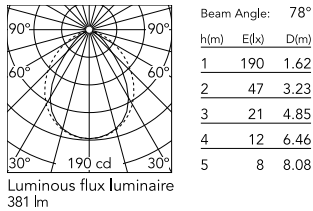

Photometric

Lighting type	Direct
Light distribution	Symmetric
CCT (K)	2700
CRI>	80
Beam angle C0-180 (°)	90
Beam angle C90-270 (°)	90

Electrical

Insulation class	III
Main voltage (Vac)	24
Power supply	Remote
Dimmable	Yes
Power supply type	Dimmable DALI PWM, Dimmable 1-10 PWM
Dimming interface	Remote Dimmable (Dimmer Not Included)
Emergency	No

Ecodesign and Energy Labelling

This product contains a light source of energy efficiency class E



Notes

We recommend using a connection system with a degree of protection greater than or equal to the degree of protection of the luminaire.

During the installation and the maintenance of the fixtures it is important to be careful and avoid damages on the paint coating.

Damages on the coating exposed to outdoor conditions or water, could cause corrosion.

Chemical substances affect the anticorrosion covering protection.

For LED fixtures, there is evidence that most of the damages are connected to electrical effects related to the insulations, which cause destructive electrical discharges

These effects are frequently caused by:

- over voltage coming from the mains' network where fixture is connected.
- electrostatic discharge (ESD) coming from the environment.

The use of a protective device against the overvoltage on the electrical installation is warmly suggest this helps to reduce the intensity of some of these phenomenon and prevent irreversible damages. The selection of the type of device to be used must be adjust on the electrical plant.

Accessories & Power Supply



REQUIRED
Accessory

F021Z010000

Plug&play connector 4 poles



REQUIRED
Accessory

F021Z090000

Double 4-pole plug&play connector + 4-pole cable, 600 mm length.



REQUIRED
Accessory

F021Z100000

4-pole plug&play connector + 4-pole cable, 5000 mm length.



REQUIRED
Accessory

F021Z070000

Cap for panel (on the fixtures) plug connector 4-5 poles



REQUIRED
Accessory

F1204030

One pair of long brackets L 200 mm. Black



REQUIRED
Accessory

F1203030

One pair of short brackets L 80 mm. Black



REQUIRED
Power supply

F990B07A000

CONTROL INTERFACE 24V PWM - DALI IP20 CLASS III. Vin 24Vdc 120W (POWER SUPPLY NOT INCLUDED)



REQUIRED
Power supply

F990B14A000

CONTROL INTERFACE 24V PWM - 1..10V IP20 CLASS III. VIN 24Vdc 120W (POWER SUPPLY NOT INCLUDED)



REQUIRED
Accessory

F990C00A000

2 way terminal block 4 poles IP68
H2O stop. (ø5,5÷12mm cable)



REQUIRED
Accessory

F990C010000

3/4 way terminal block 4 poles
IP68 H2O stop. (ø5,5÷12mm
cable)



REQUIRED
Power supply

F990B27A000

Power supply 24Vdc 70W / 220-
240V IP67 Class I selv. Non
Dimmable



REQUIRED
Power supply

F990B28A000

Power supply 24Vdc 50W / 220-
240V IP67 Class I selv. Non
Dimmable



REQUIRED
Power supply

F990B29A000

Power supply 24Vdc 100W / 220-
240V IP67 Class I selv.Non
Dimmable