

# FLOS

09.3750.14A9S Black

## Find Me 1 (Trim/No Trim)

Designed by Jorge Herrera, 2016



Hide-and-go-seek brought to light. The versatile Find Me is a tiny semi-recessed downlight hidden in the ceiling until otherwise sought. With a simple pull, the downlight can extend below the ceiling and transform into a refined cylindrical monopoint. This diminutive yet powerful luminaire is endlessly versatile and can tilt 90 degrees and rotate 360 degrees. Deep matte black snoot maximizes cut off and reduces glare. The Find Me line is available as a single with trim or without and as a pendant.

Are you a professional and your project needs consulting and support?

[BOOK AN APPOINTMENT](#)

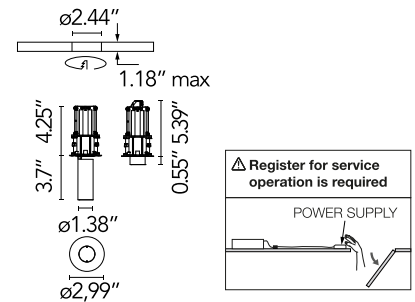

### Main specifications

Mounting	Ceiling recessed
Environments	Indoor dry location
Light Source Type	LED
Light sources included	Yes
LED type	Power LED
Lamp category	LED
Number of lamps	1
Power (W)	6
System flux (lm)	365

### Physical

Color	Black
Orientation	Adjustable
Rotation (°)	360
Longitudinal tilting (°)	90
Recessed depth (in)	5.4
Net weight (lb)	0.51
Package volume (in)	428
IP internal	20

### Download

Family spec sheet [↓ ZIP](#)  
Mounting instructions [↓ PDF](#)

### Photometric Files

LDT / IES [↓ ZIP](#)

### Ecodesign and Energy Labelling

 Replaceable (LED only) light source by a professional  
 ↔ 



## Schematic light drawing

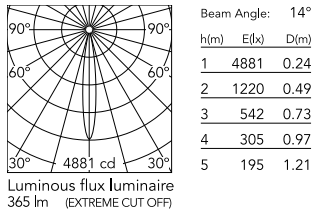

### Photometric

Lighting type	Direct
Light distribution	Symmetric
CCT (K)	3000
CRI>	90
Beam angle C0-180 (°)	14
Beam angle C90-270 (°)	14
UGR <sub>L</sub>	<10

### Electrical

Insulation class	III
Forward voltage (V)	12
LED current (mA)	500
Driver	Remote excluded
Dimmable	Yes

### Notes

Integral LED is not field replaceable. IC-rated downlight for direct insulation contact. Fixture is constant Current Low Voltage LED, Class 2. Just 1 accessory can be install at the time. For filter options contact Flos. Wiring suitable for plenum spaces. Maximum remote distance is 50ft with 16ga. 3500K available, but not cataloged. Consult factory for additional color temperatures. Accessories included (honeycomb and screening crosspiece). Remote power supply to be installed in an accessible place. It is not recommended to use dimmable drivers of several brands due to the specific dimming curves of each brand. To use only one driver for various spots, connect the spots in series. Register for service operation is required.

## Accessories & Power Supply

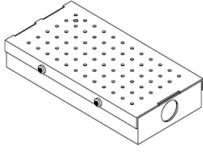

REQUIRED  
Power supply

Electrical

LEDSB14W500MA-LTE-S01  
Splice Box UL 7"x3-5/8"x1-1/4",  
Dim Hi-lume 1% 2-Wire LED  
Driver, 500mA , 14W, 120V

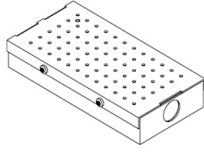

REQUIRED  
Power supply

Electrical

LEDSB26W500MA-LTE-S01  
Splice Box UL 7"x3-5/8"x1-1/4",  
Dim Hi-lume 1% 2-Wire LED  
Driver, 500mA , 26W, 120V

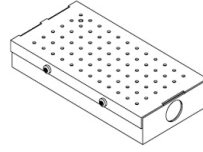

REQUIRED  
Power supply

Electrical

SP40W500MA-10V-A02  
Splice Box 40W, 1% dim, 0-10V,  
500mA 120/277V.

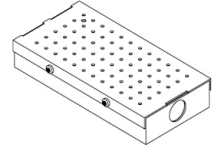

REQUIRED  
Power supply

Electrical

SP25W500MA-10V-A01  
Splice Box UL 7"x3-5/8"x1-1/4",  
500mA , 25W, 0-10V Dimmable,  
120-277V

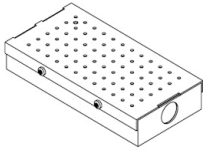

REQUIRED  
Power supply

Electrical

SP30W500MA-ELV-U01  
Splice Box UL 7"x3-5/8"x1-1/4",  
500mA , 30W, ELV Dimmable,  
120-277V