

A LUMINAIRE INSTALLATION

INSTALACIÓN DE LA LUMINARIA / INSTALLAZIONE DELLA LAMPADA /
 INSTALLATION DER BELEUCHTUNG / INSTALLATION DU LUMINAIRE /
 INSTALAÇÃO DO APARELHO DE ILUMINAÇÃO / 照明器具の設置・据付け /
 灯具的安装 / МОНТАЖ ОСВЕТИТЕЛЬНОГО ПРИБОРА
 ШАМДЛАДЫ ОРНАТУ / تركيب وحدة الإنارة

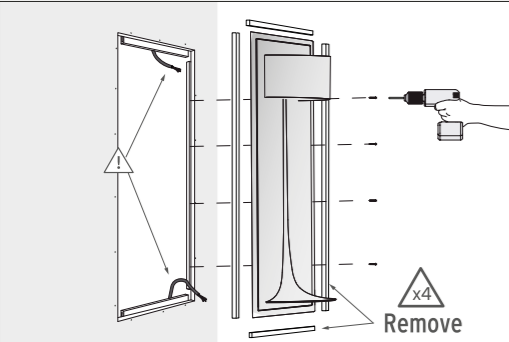

Soft Spun Small 1 Connection Cable
 Soft Spun Large 2 Connection Cable

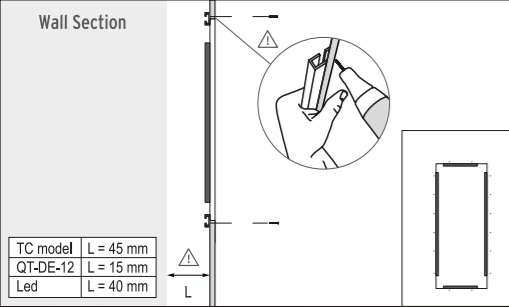
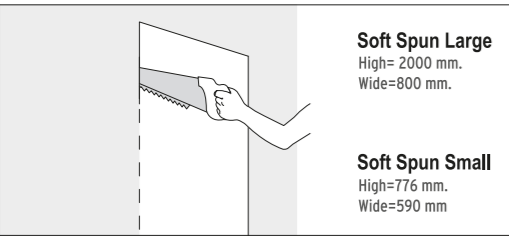
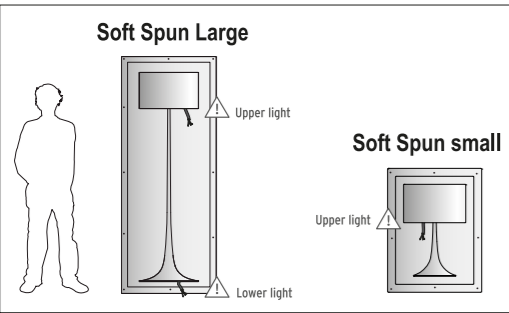
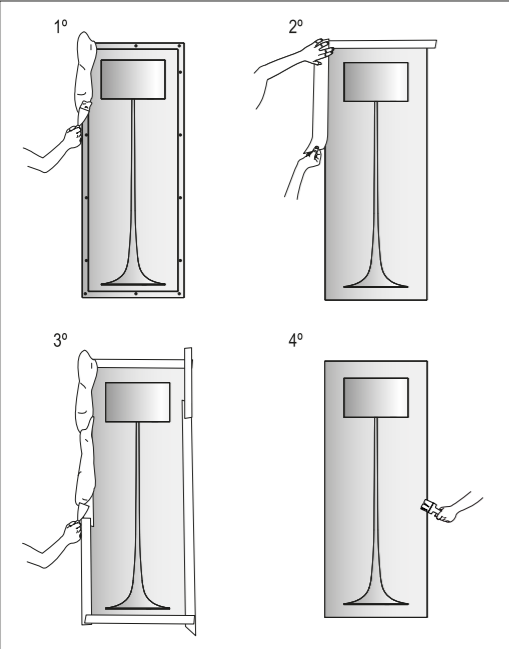

1. UPPER LIGHT

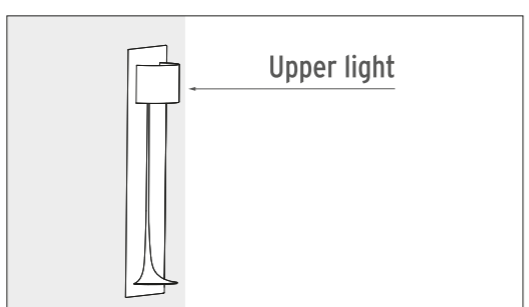

A.1 Soft Spun TC-L

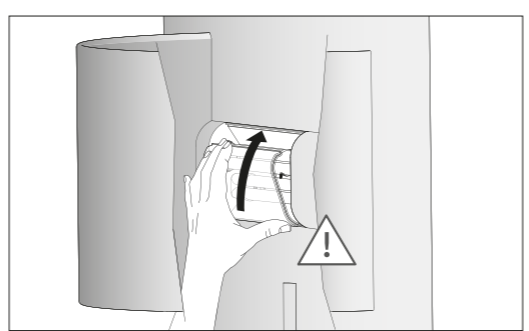
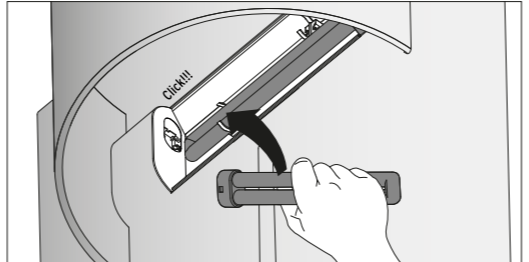
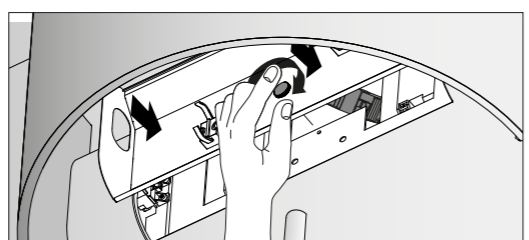
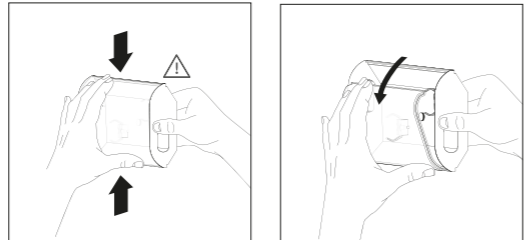
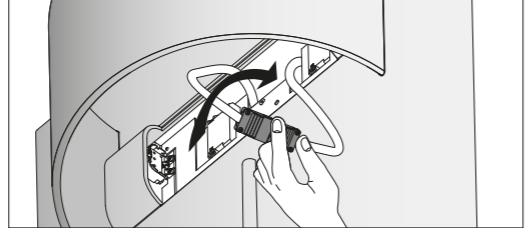
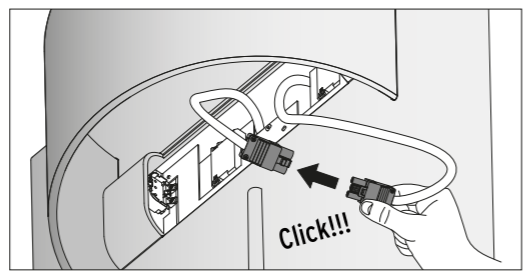
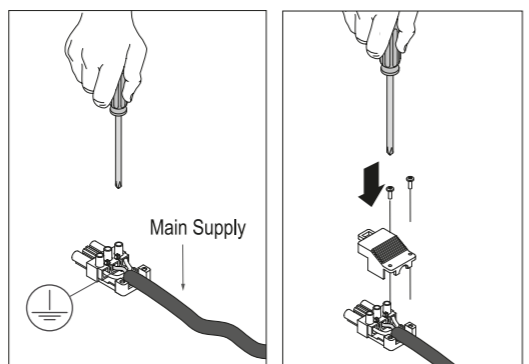
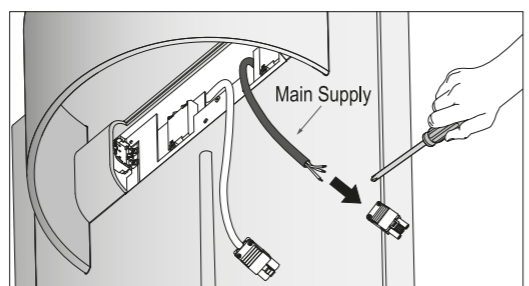

A.2 Soft Spun QT-DE-12

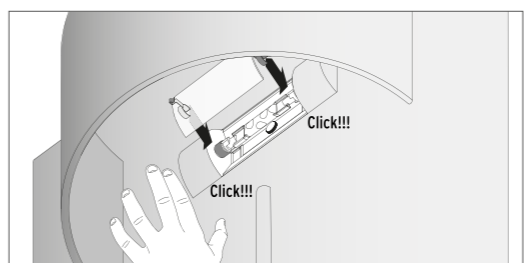
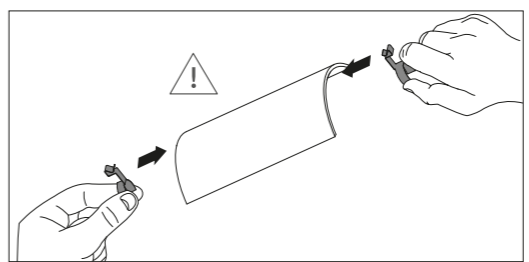
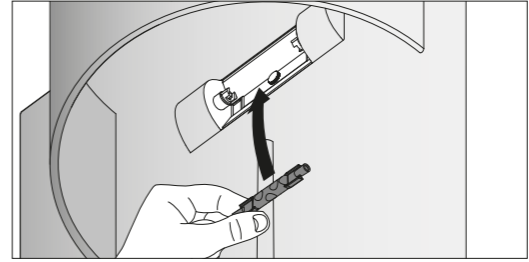
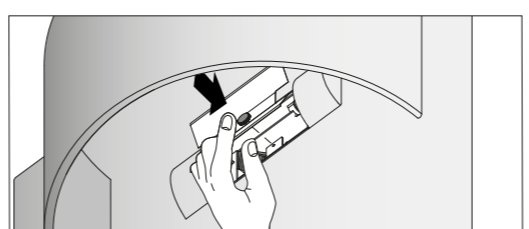
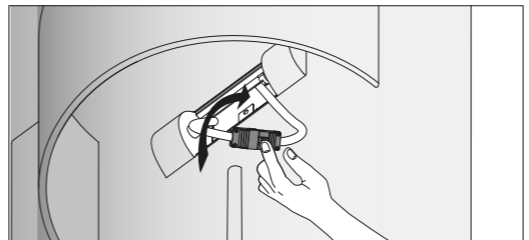
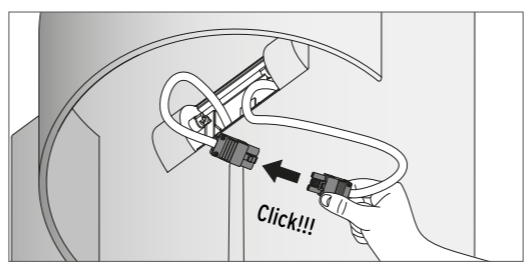
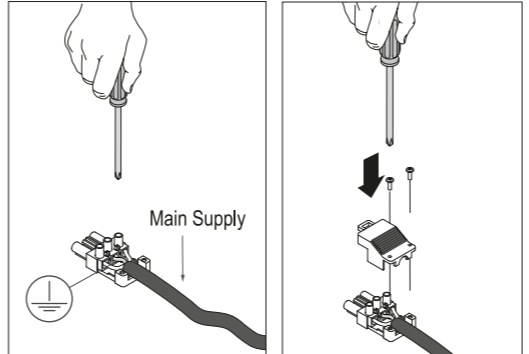
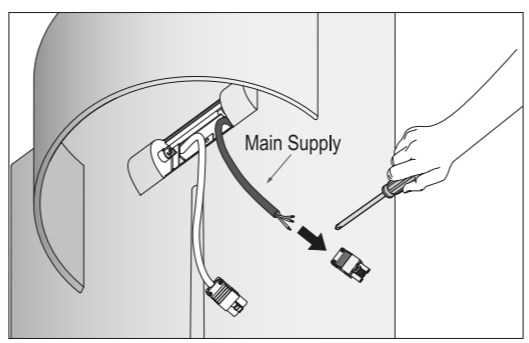

A.3 Soft Spun LED Fortimo LLM

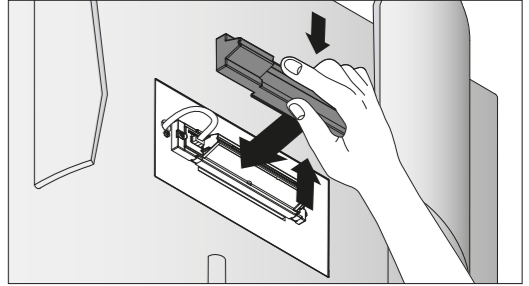
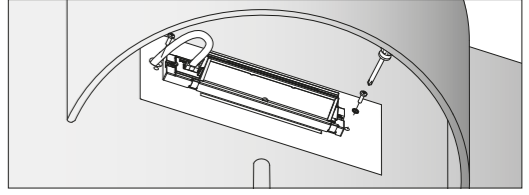
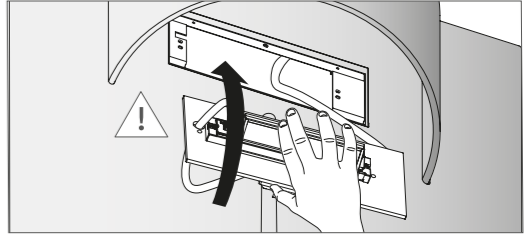
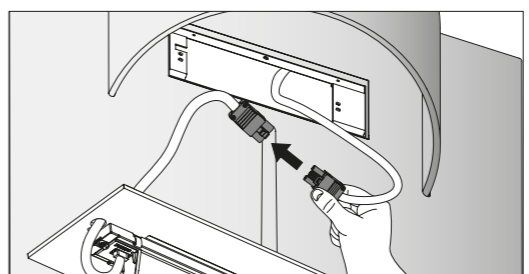
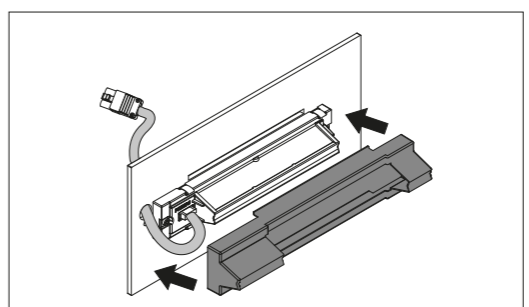
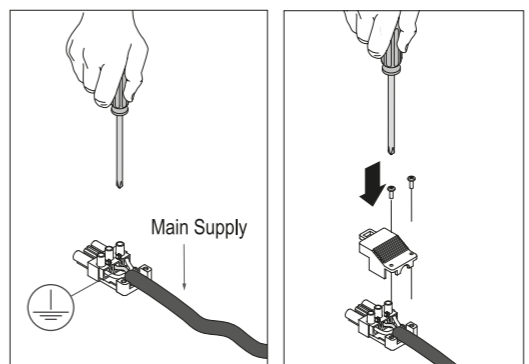
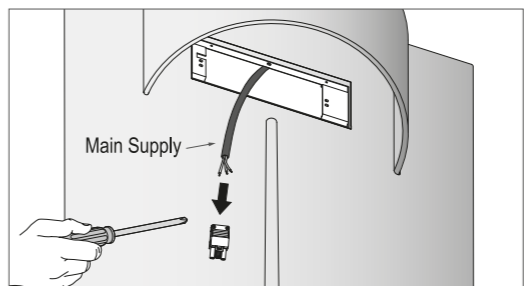

2. Lower light

