

RF7542100

Base for To-Tie Table 2



WARNING! When installing and whenever acting on the appliance, ensure that the power supply has been switched off.
For the installation of the spare-part, it is necessary to consult a qualified electrician.

RF7542100

Base for To-Tie Table 2

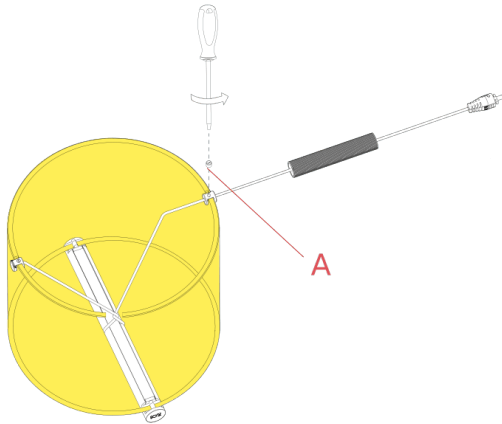

Fig.1

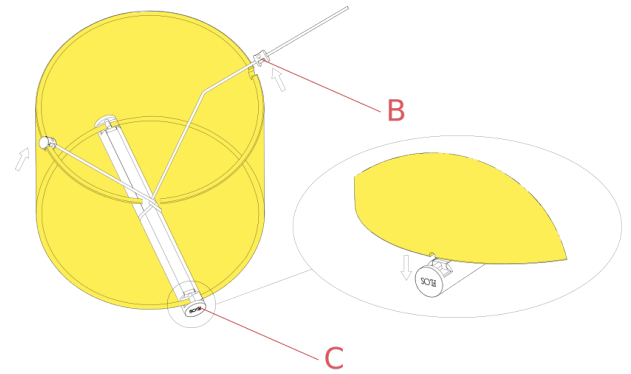

Fig.2

Unfasten the screws (A) using the screwdriver.
Remove the rubber cable clips (B) from the glass diffuser.
Push down the electrical body assembly (C) raising up the glass diffuser.

WARNING! When installing and whenever acting on the appliance, ensure that the power supply has been switched off.
For the installation of the spare-part, it is necessary to consult a qualified electrician.

RF7542100

Base for To-Tie Table 2

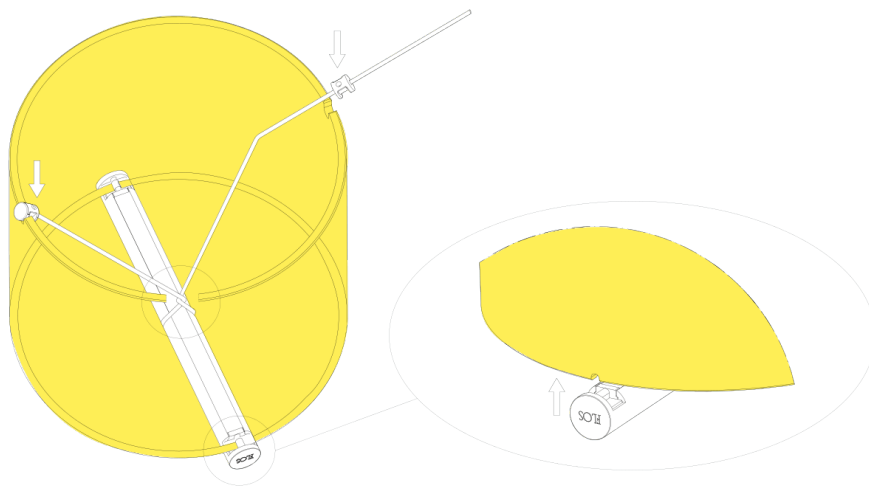

Fig.3

Assemble now the new spare part.
Position the electrical cable as shown in the figure.
Reposition the rubber cable clips in their housing. Connecting the electrical body assembly in the glassdiffuser.

WARNING! When installing and whenever acting on the appliance, ensure that the power supply has been switched off.
For the installation of the spare-part, it is necessary to consult a qualified electrician.

RF7542100

Base for To-Tie Table 2

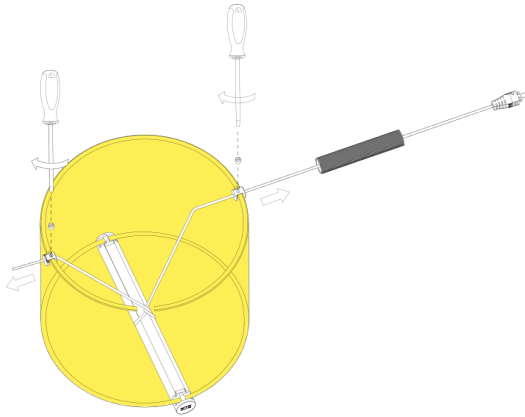

Fig.4

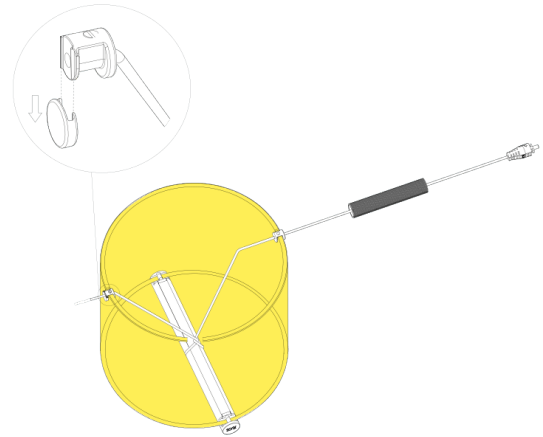

Fig.5

Fix the rubber cable clips to the glass cylinder.
Cut the excess cable and place the closing terminal.

WARNING! When installing and whenever acting on the appliance, ensure that the power supply has been switched off.
For the installation of the spare-part, it is necessary to consult a qualified electrician.