

IC T1 LOW

Designed by Michael Anastassiades, 2014

F3171059

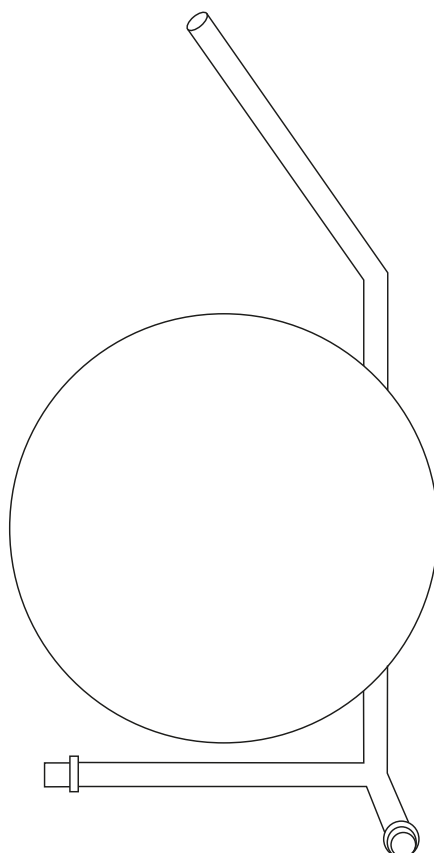

IC T1 LOW

F3171059

EN

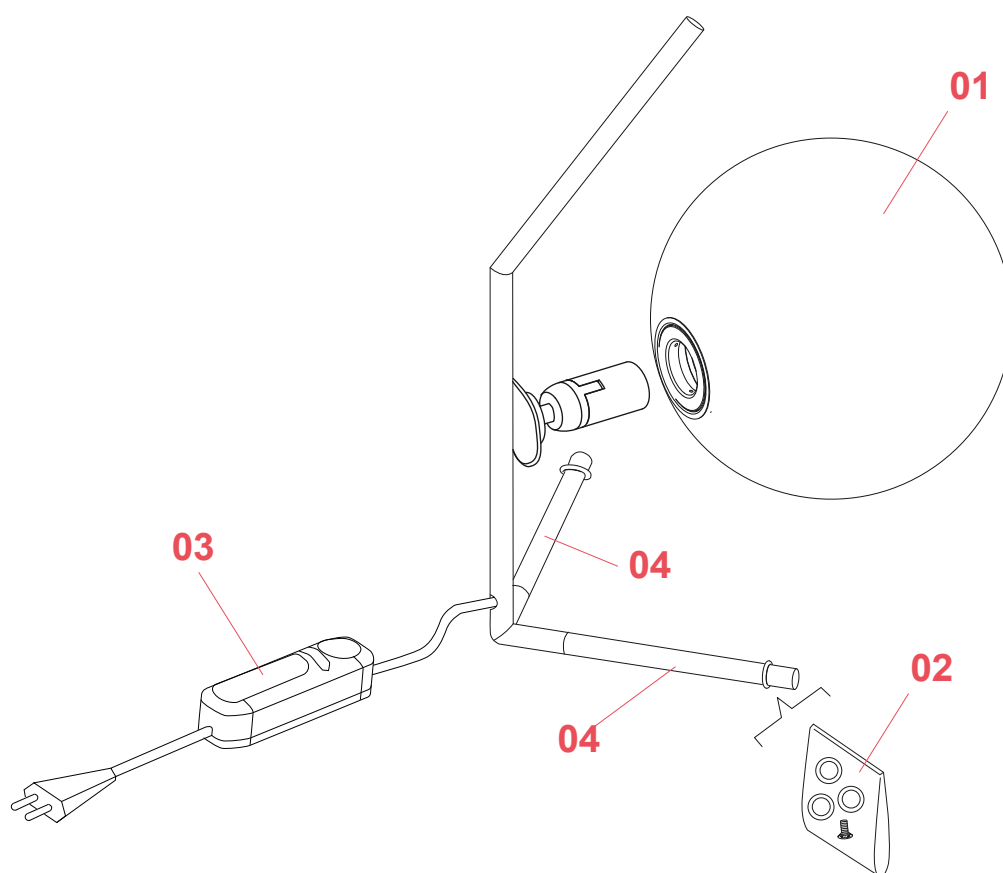

01. F3136059 – Glass diffuser 1 assembly for brass version

02. RF3160400 – Gasket with foot kit for IC High - Low

03. RF28206 – Black Led dimmer 1004P LFP100-240V 4-150WHL 4-25W

04. RF23317 – Lower brass leg

IC T1 LOW F3171059

EN

F3136059

GLASS DIFFUSER 1 ASSEMBLY FOR BRASS VERSION



Ic-CW1
p.03

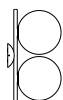

Ic-CW1
double
p.03

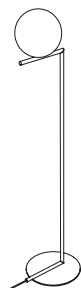

Ic-F1
p.03



Ic-S1
p.03



Ic T1
High
p.03



Ic T1
Low
p.03

WARNING! When installing and whenever acting on the appliance, ensure that the power supply has been switched off.
For the installation of the spare-part, it is necessary to consult a qualified electrician.

ICT1 LOW F3171059

EN

F3136059

GLASS DIFFUSER 1 ASSEMBLY FOR BRASS VERSION

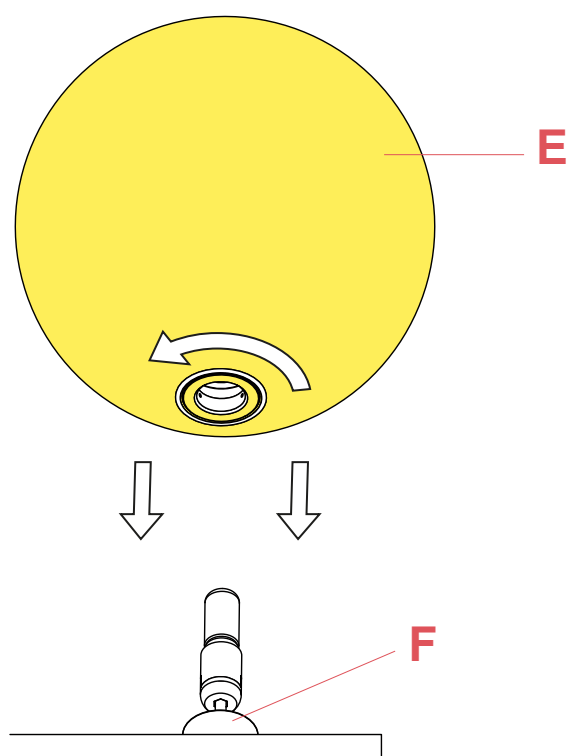

Fig.1

Assemble the glass diffuser (E) by fastening it delicately to the lamp body's ferrule (F).

WARNING! When installing and whenever acting on the appliance, ensure that the power supply has been switched off.
For the installation of the spare-part, it is necessary to consult a qualified electrician.

IC T1 LOW F3171059

EN

RF3160400

GASKET AND FOOT KIT FOR IC HIGH-LOW



Ic T1
High
p.05



Ic T1
Low
p.05

WARNING! When installing and whenever acting on the appliance, ensure that the power supply has been switched off.
For the installation of the spare-part, it is necessary to consult a qualified electrician.

ICT1 LOW F3171059

EN

RF3160400

GASKET AND FOOT KIT FOR IC HIGH-LOW

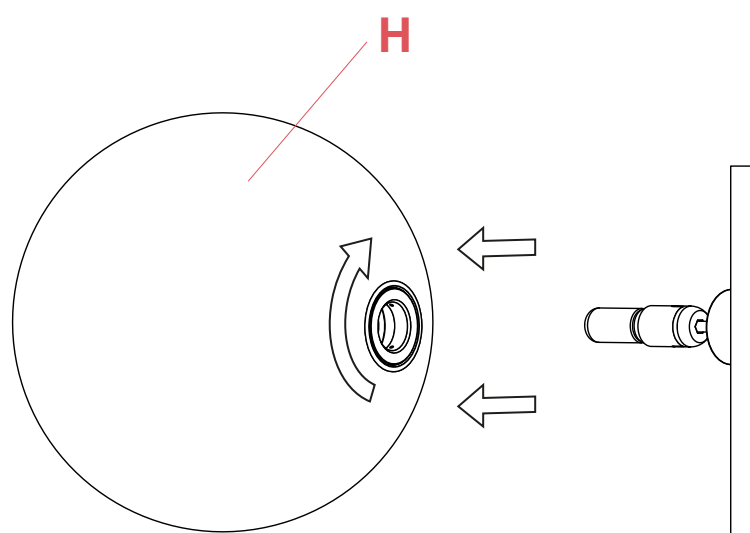

Fig.1

Before proceeding in installing the screws, please verify that the glass diffuser (H) has been removed. If not, please remove to the glass diffuser (H) to avoid possible damages.

WARNING! When installing and whenever acting on the appliance, ensure that the power supply has been switched off.
For the installation of the spare-part, it is necessary to consult a qualified electrician.

©2021 Flos - All rights reserved - www.flos.com
Flos reserves the right to introduce any changes to its own models, without prior notice.

ICT1 LOW F3171059

EN

RF3160400

GASKET AND FOOT KIT FOR IC HIGH-LOW

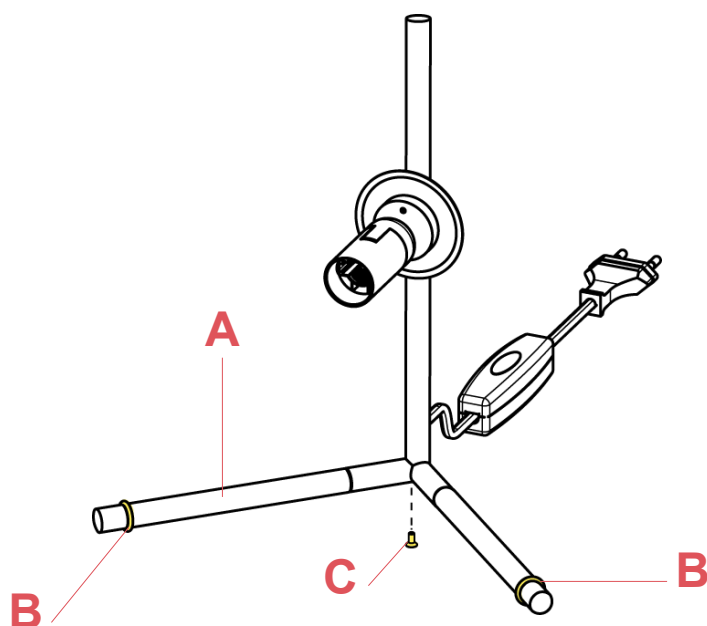

Fig.2

Collocate the gaskets (B) on the bars (A) and insert the foot (C) under the lamp body stem.

WARNING! When installing and whenever acting on the appliance, ensure that the power supply has been switched off.
For the installation of the spare-part, it is necessary to consult a qualified electrician.

©2021 Flos - All rights reserved - www.flos.com
Flos reserves the right to introduce any changes to its own models, without prior notice.















ICT1 LOW F3171059

EN

RF28206

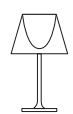
LED DIMMER 1004P LFP100-240V 4-150WHL 4-25W

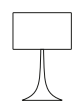
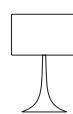
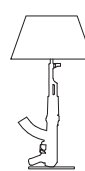

								
Bedside Gun p.12	Chiara T p.03	Glo-ball Basic 0 p.11	Glo-ball Basic 1 p.14	Glo-ball Basic 2 p.05	Glo-ball T1 p.11	Ic T1 High p.08	Ic T1 Low p.08	Ic T2 p.08
								
Ktribe T1 p.05	Ktribe T2 p.05	Miss K p.13	Ray T p.17	Romeo Moon T1 p.32	Romeo Soft T1 p.32	Spun Light T1 p.12	Spun Light T2 p.12	Table Gun p.12

WARNING! When installing and whenever acting on the appliance, ensure that the power supply has been switched off.
For the installation of the spare-part, it is necessary to consult a qualified electrician.

ICT1 LOW F3171059

EN

RF28206

LED DIMMER 1004P LFP100-240V 4-150WHL 4-25W



Fig.1



Fig.2

Open the dimmer box of the damaged dimmer.
For the opening, it is necessary to remove the n°2 screws using a star screw driver.

Lift-up the dimmer casing from the dimmer base;

WARNING! When installing and whenever acting on the appliance, ensure that the power supply has been switched off.
For the installation of the spare-part, it is necessary to consult a qualified electrician.

ICT1 LOW F3171059

EN

RF28206

LED DIMMER 1004P LFP100-240V 4-150WHL 4-25W

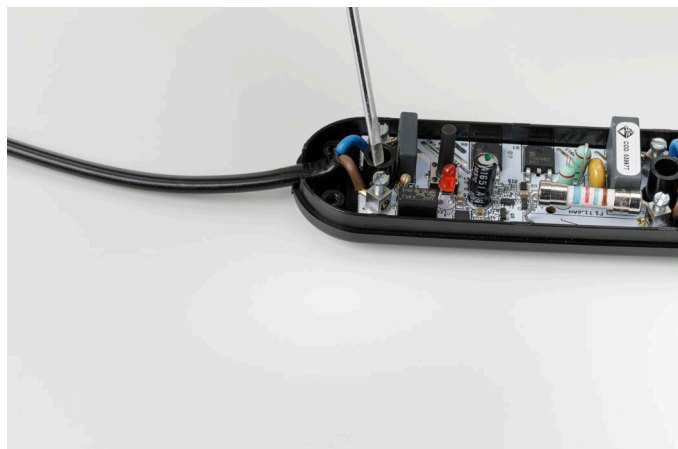

Fig.3

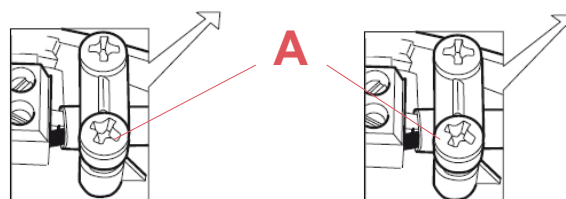

Fig.3.1

Remove the cable clamps by unfastening the 4 screws (A) and disconnect the wires from the terminal blocks through a tiny flat headed screw driver;



Fig.4

Replace the dimmer and connect the wires. When connecting the wires it is necessary to respect the polarities (L = Brown and N = Blue) to the terminal box.

Lock the electrical cables by fastening the screws (A) of the cable clamps and make sure to block the isolation of the electrical cable.

Close the dimmer box.

It is necessary to place the casing on top and press down until it locks in.

it is necessary to insert the n°2 screws using a star screw driver

WARNING! When installing and whenever acting on the appliance, ensure that the power supply has been switched off. For the installation of the spare-part, it is necessary to consult a qualified electrician.

IC T1 LOW F3171059

EN

RF23317

LOWER BRASS LEG

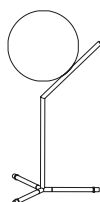

Ic T1
High
p.11

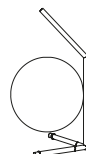

Ic T1
Low
p.11

WARNING! When installing and whenever acting on the appliance, ensure that the power supply has been switched off.
For the installation of the spare-part, it is necessary to consult a qualified electrician.

ICT1 LOW F3171059

EN

RF23317

LOWER BRASS LEG

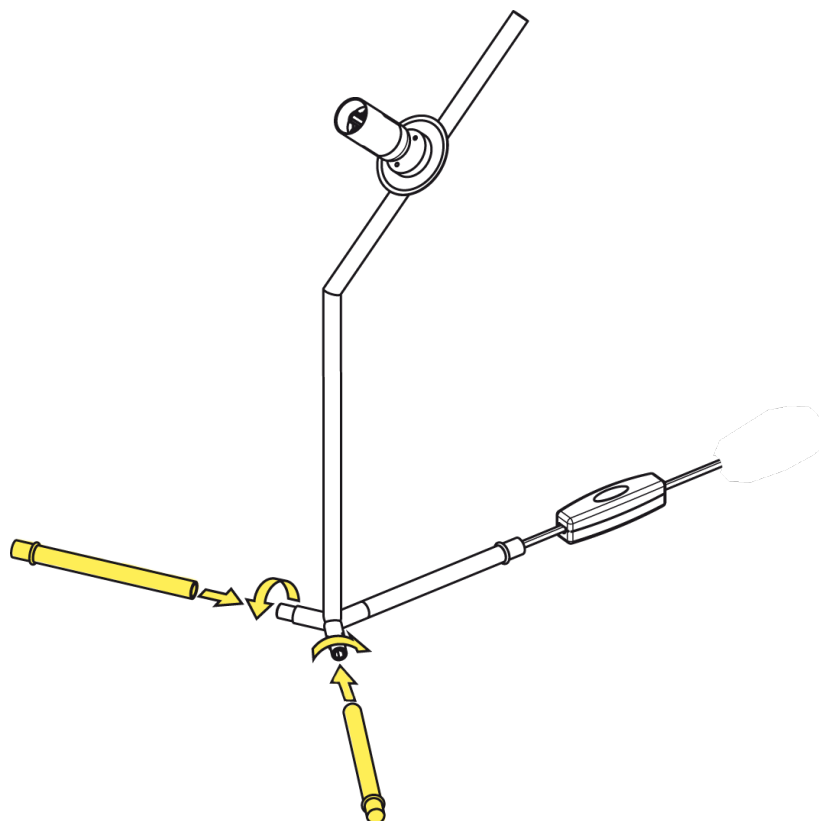

Fig.1

Unscrew the old legs and remove them from the body lamp.

Screw the new legs in the body lamp (see the picture)

WARNING! When installing and whenever acting on the appliance, ensure that the power supply has been switched off.
For the installation of the spare-part, it is necessary to consult a qualified electrician.