

RF18844

Lamp holder fitting e14



WARNING! When installing and whenever acting on the appliance, ensure that the power supply has been switched off.
For the installation of the spare-part, it is necessary to consult a qualified electrician.

RF18844

Lamp holder fitting e14



Fig.1



Fig.2

Remove the diffuser (C) and remove the lamp-bulb.

WARNING! When installing and whenever acting on the appliance, ensure that the power supply has been switched off.
For the installation of the spare-part, it is necessary to consult a qualified electrician.

RF18844

Lamp holder fitting e14



Fig.3

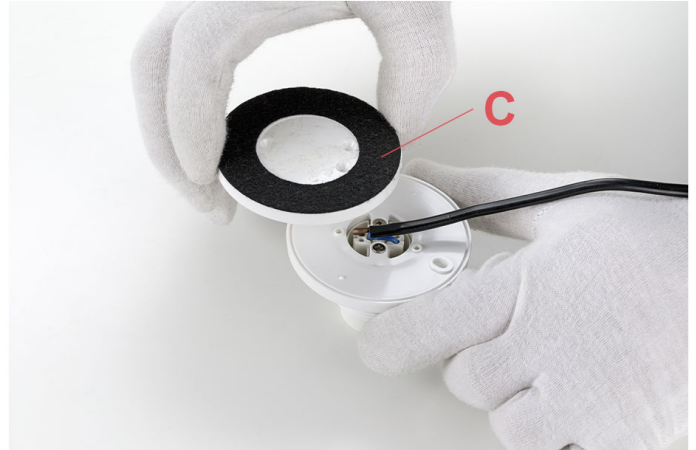

Fig.4

Unfasten the two fixing screws (B) and disconnect the electrical wires (A) from the lamp holder by pressing the push terminals with a paper clip (D) or something similar.

WARNING! When installing and whenever acting on the appliance, ensure that the power supply has been switched off.
For the installation of the spare-part, it is necessary to consult a qualified electrician.

RF18844

Lamp holder fitting e14



Fig.5



Fig.6

Unfasten the two lamp holder fixing screws (E) and remove from the assembly the lamp holder (F).

WARNING! When installing and whenever acting on the appliance, ensure that the power supply has been switched off.
For the installation of the spare-part, it is necessary to consult a qualified electrician.

RF18844

Lamp holder fitting e14

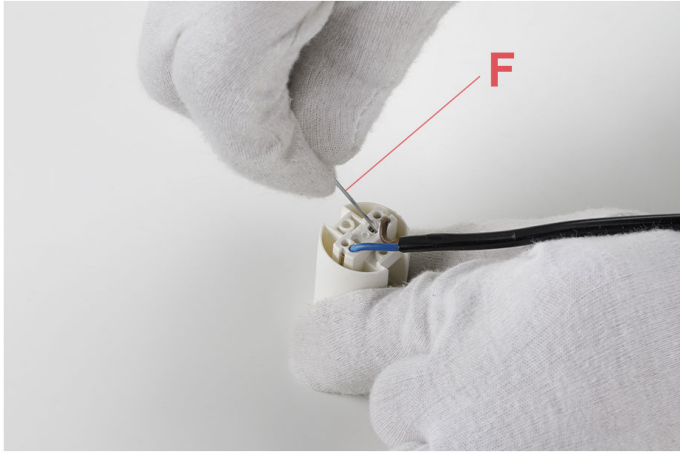

Fig.5

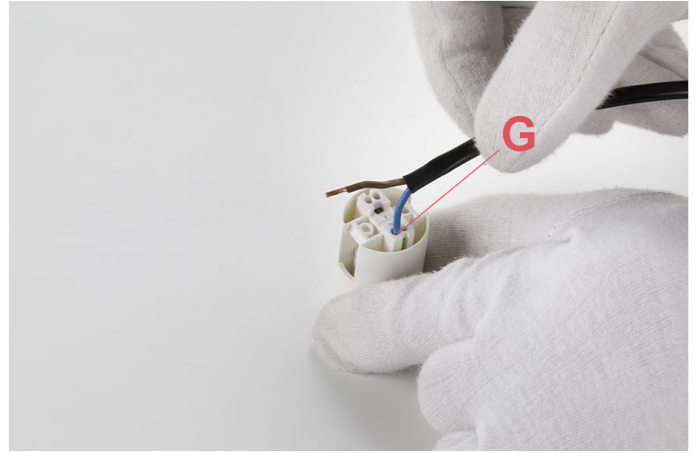

Fig.6

Assemble now the new spare-part:

Insert the two lamp holder fixing screws (E) (Fig.4 page 8) inside the two holes present on the lamp assembly. Turn the assembly around with the lamp holder fixing screws and insert the two black spacers (G) inside the screws.

Insert the two lamp holder (F) (Fig.5 page 8). The holes present on the lamp holder must correspond with the screws on the lamp assembly. (Fig.7)

Turn the lamp assembly and fasten the two fixing screws (E)(Fig.4page8) of the lamp holder.

WARNING! When installing and whenever acting on the appliance, ensure that the power supply has been switched off. For the installation of the spare-part, it is necessary to consult a qualified electrician.

RF18844

Lamp holder fitting e14

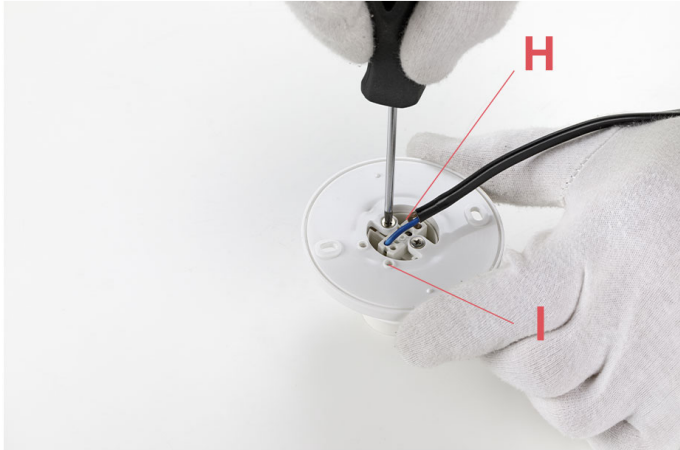

Fig.9

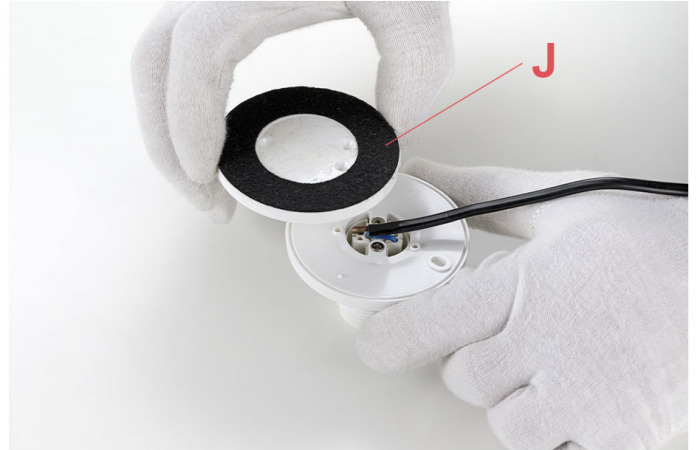

Fig.10



Fig.11



Fig.12

Insert the sheaths (I) in the power supply electrical wires (A). Connect the electrical wires to the lamp holder.
 Fix the lamp assembly (H) by fastening the screws (B).
 Insert the lamp bulb and screw the diffuser (C) to the lamp assembly (H).

WARNING! When installing and whenever acting on the appliance, ensure that the power supply has been switched off.
 For the installation of the spare-part, it is necessary to consult a qualified electrician.

RF18844

Lamp holder fitting e14

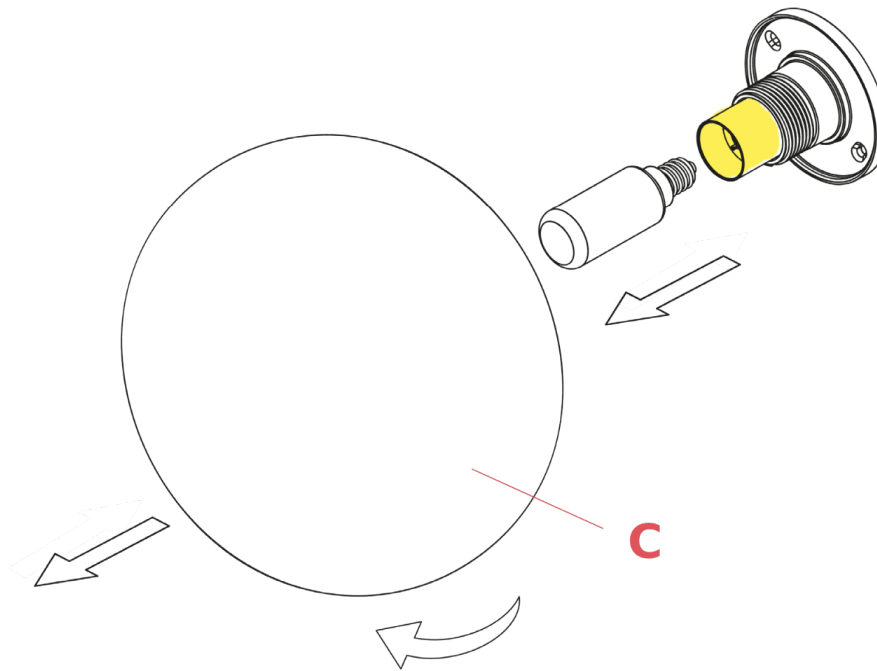

Fig.1

Remove the diffuser (C) and remove the lamp-bulb.

WARNING! When installing and whenever acting on the appliance, ensure that the power supply has been switched off.
For the installation of the spare-part, it is necessary to consult a qualified electrician.

RF18844

Lamp holder fitting e14



Fig.3

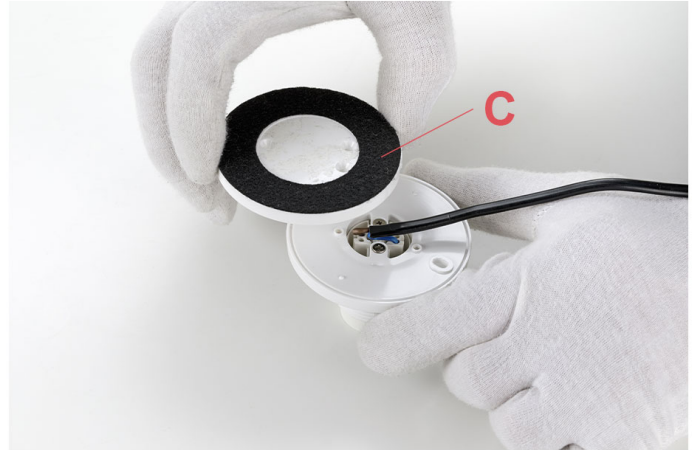

Fig.4

Unfasten the two fixing screws (B) and disconnect the electrical wires (A) from the lamp holder by pressing the push terminals with a paper clip (D) or something similar.

WARNING! When installing and whenever acting on the appliance, ensure that the power supply has been switched off.
For the installation of the spare-part, it is necessary to consult a qualified electrician.

RF18844

Lamp holder fitting e14



Fig.4



Fig.5

Unfasten the two lamp holder fixing screws (E) and remove from the assembly the lamp holder (F).

WARNING! When installing and whenever acting on the appliance, ensure that the power supply has been switched off.
For the installation of the spare-part, it is necessary to consult a qualified electrician.

RF18844

Lamp holder fitting e14



Fig.6

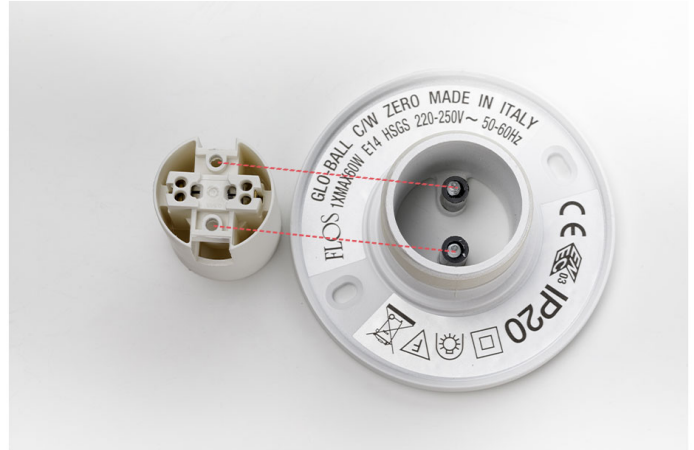

Fig.7

Assemble now the new spare-part:

Insert the two lamp holder fixing screws (E) (Fig.4 page 8) inside the two holes present on the lamp assembly. Turn the assembly around with the lamp holder fixing screws and insert the two black spacers (G) inside the screws.

Insert the two lamp holder (F) (Fig.5 page 8). The holes present on the lamp holder must correspond with the screws on the lamp assembly.(Fig.7)

Turn the lamp assembly and fasten the two fixing screws (E)(Fig.4page8) of the lamp holder.

WARNING! When installing and whenever acting on the appliance, ensure that the power supply has been switched off. For the installation of the spare-part, it is necessary to consult a qualified electrician.

RF18844

Lamp holder fitting e14

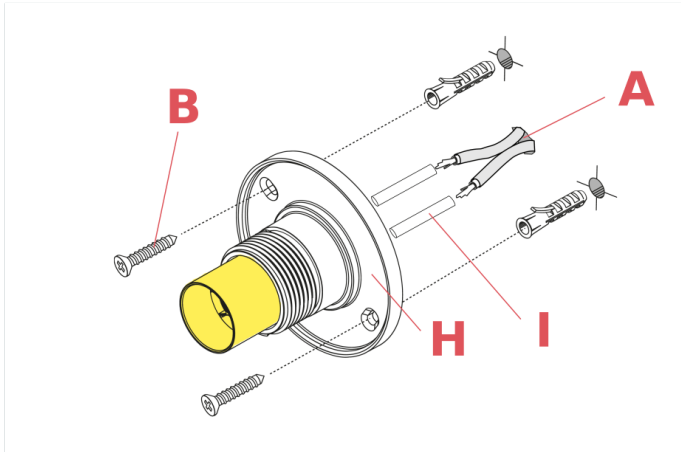

Fig.8

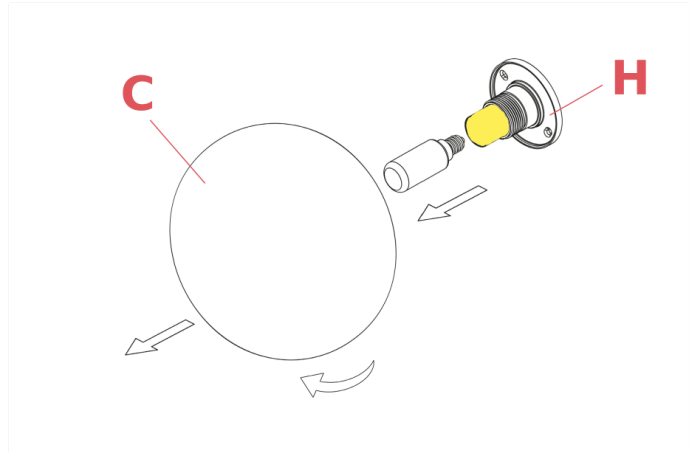

Fig.9

Insert the sheaths (I) in the power supply electrical wires (A). Connect the electrical wires to the lamp holder.
Fix the lamp assembly (H) by fastening the screws (B).
Insert the lamp bulb and screw the diffuser (C) to the lamp assembly (H).

WARNING! When installing and whenever acting on the appliance, ensure that the power supply has been switched off.
For the installation of the spare-part, it is necessary to consult a qualified electrician.