

RF03927

E27 Lamp Holder Black



WARNING! When installing and whenever acting on the appliance, ensure that the power supply has been switched off.
For the installation of the spare-part, it is necessary to consult a qualified electrician.

RF03927

E27 Lamp Holder Black

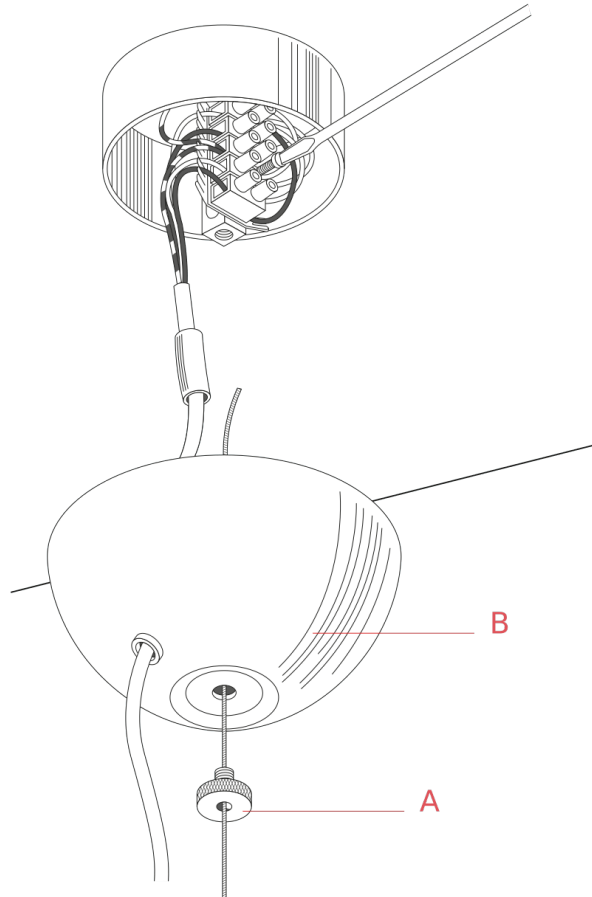

Fig.1

It is necessary to remove the lamp body down from the ceiling.
Unfasten the knurled screw (A) and disassemble the ceiling rose (B).
Disconnect the device electrical wires from the terminal box and unlock the suspension steel wire.
REMARKS! Ask another person to help keep the body lamp whilst carrying-out the operation.

WARNING! When installing and whenever acting on the appliance, ensure that the power supply has been switched off.
For the installation of the spare-part, it is necessary to consult a qualified electrician.

RF03927

E27 Lamp Holder Black



Fig.2



Fig.3

Open the lamp body by starting from the upper adjacent triangle.

Open the triangle by removing the two black OR rings (I) from the linchpin (J). Slide out the linchpin (J) by utilizing a pair of pliers.

Repeat the same operation on the other triangles and on the other sides if necessary.

Very briefly, it is essential to open the lamp body in segments to carry-out the replacement of the spare-part.

WARNING! When installing and whenever acting on the appliance, ensure that the power supply has been switched off.
For the installation of the spare-part, it is necessary to consult a qualified electrician.

RF03927

E27 Lamp Holder Black

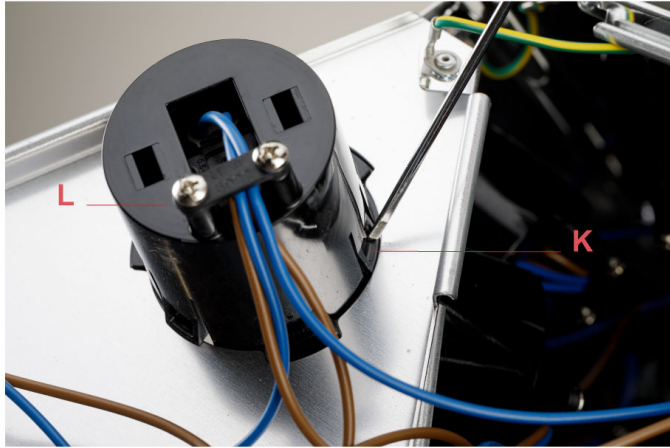

Fig.4

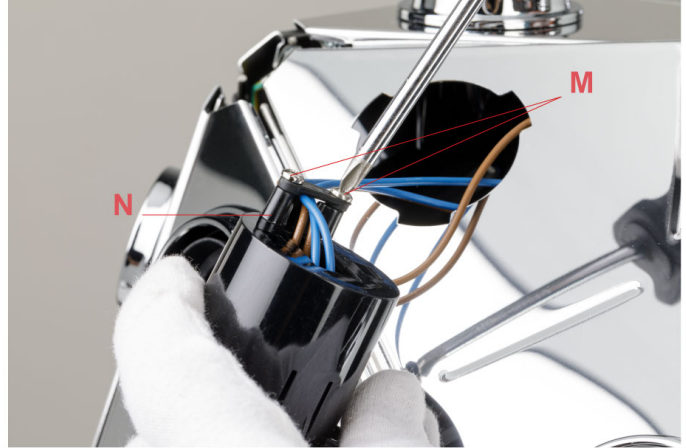

Fig.5

To slide out the ring nut and lamp holder assembly (L) from the triangle it is necessary to press the three fins (K) and push the assembly out.

Remove the cable clamp (N) unfastening the screws (M).

WARNING! When installing and whenever acting on the appliance, ensure that the power supply has been switched off.
For the installation of the spare-part, it is necessary to consult a qualified electrician.

RF03927

E27 Lamp Holder Black

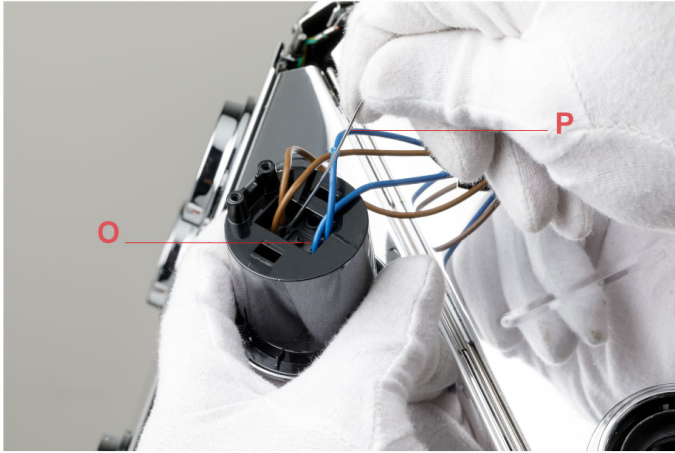

Fig.6



Fig.7

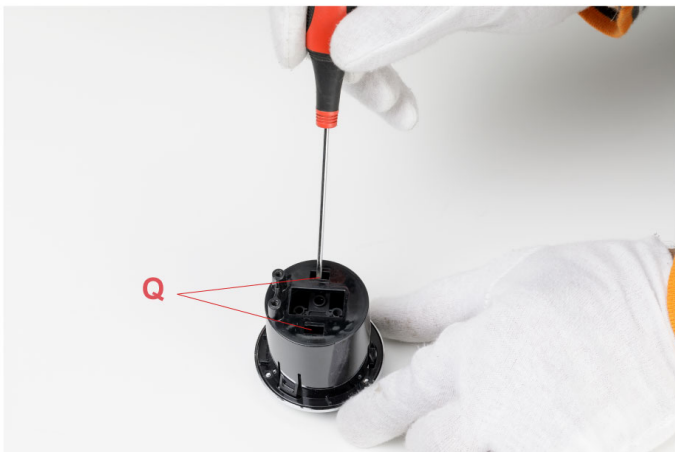

Fig.8

Disconnect the electrical wires (O) from the lamp holder by pressing the push terminals with a paper clip (P).(Fig.6)

To remove the lamp holder (R) from the ring nut (S), it is necessary to push the internal clips (Q) with a flat headed screw driver.(Fig.7-8)

WARNING! When installing and whenever acting on the appliance, ensure that the power supply has been switched off. For the installation of the spare-part, it is necessary to consult a qualified electrician.

RF03927

E27 Lamp Holder Black



Fig.9



Fig.10

Assemble now the new spare-part:
Insert the lamp holder (R) in the ring nut (S) and lock it through its opposite internal clips (Q).

WARNING! When installing and whenever acting on the appliance, ensure that the power supply has been switched off.
For the installation of the spare-part, it is necessary to consult a qualified electrician.

RF03927

E27 Lamp Holder Black



Fig.11



Fig.12

Connect the electrical wires of the lamp holder. Connect the Brown "L" (live) wires in the terminal that corresponds (opposite side) to the centre brass contact of the lamp holder and then connect the Blue "N" (neutral) wires in the other terminal.

N.B. The electrical wires are connected by pushing the wires inside the terminals, therefore it is necessary to verify that they are connected properly.

Now, reassemble the lamp:

Assemble the cable clamp (M) by fastening the screws (N). (Fig.5 page 3)

Lock back inside the triangle the ring nut and lamp holder assembly (L). (Fig.4 page 3)

Assemble the triangle by inserting the linchpin (J) in the hinges of the triangles and then insert at the double-ends of the linchpin (J) the black OR rings. (Fig.2 page 2)

Connect the electrical wires and lock the steel suspension wire.

Cover the ceiling attachment with the rose (B) and then fix the assembly by fastening the knurled screw (A). (Fig.1 page 1)

WARNING! When installing and whenever acting on the appliance, ensure that the power supply has been switched off. For the installation of the spare-part, it is necessary to consult a qualified electrician.

RF03927

E27 Lamp Holder Black

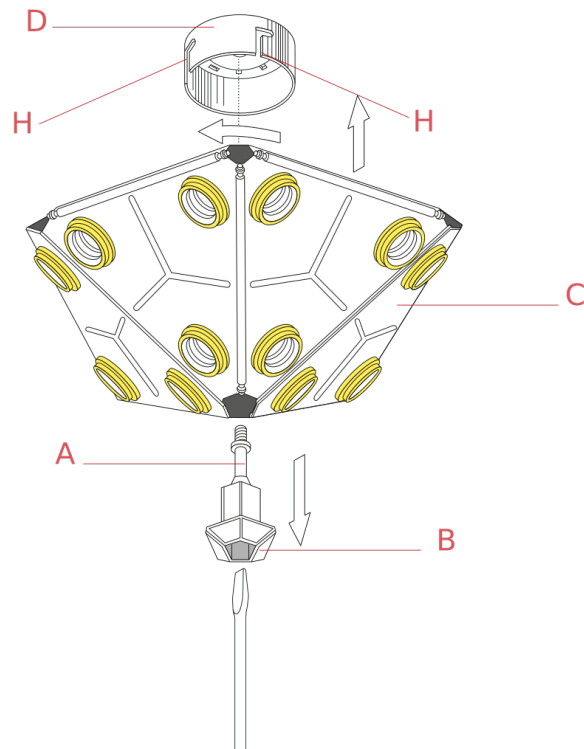

Fig.1

Unfasten the screw (A) in the bell (B). Unhook the lamp body (C) from the wall attachment (D).

WARNING! When installing and whenever acting on the appliance, ensure that the power supply has been switched off.
For the installation of the spare-part, it is necessary to consult a qualified electrician.

RF03927

E27 Lamp Holder Black

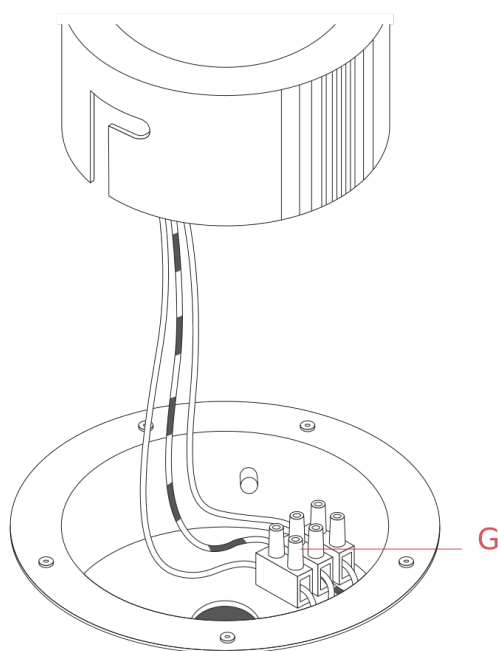

Fig.2

Free the lamp body by disconnecting the feed wires from the terminal box (G).

WARNING! When installing and whenever acting on the appliance, ensure that the power supply has been switched off.
For the installation of the spare-part, it is necessary to consult a qualified electrician.

RF03927

E27 Lamp Holder Black



Fig.3



Fig.4

Open the lamp body by starting from the upper adjacent triangle.

Open the triangle by removing the two black OR rings (I) from the linchpin (J). Slide out the linchpin (J) by utilizing a pair of pliers.

Repeat the same operation on the other triangles and on the other sides if necessary.

Very briefly, it is essential to open the lamp body in segments to carry-out the replacement Fig.4 of the spare-part.

WARNING! When installing and whenever acting on the appliance, ensure that the power supply has been switched off. For the installation of the spare-part, it is necessary to consult a qualified electrician.

RF03927

E27 Lamp Holder Black

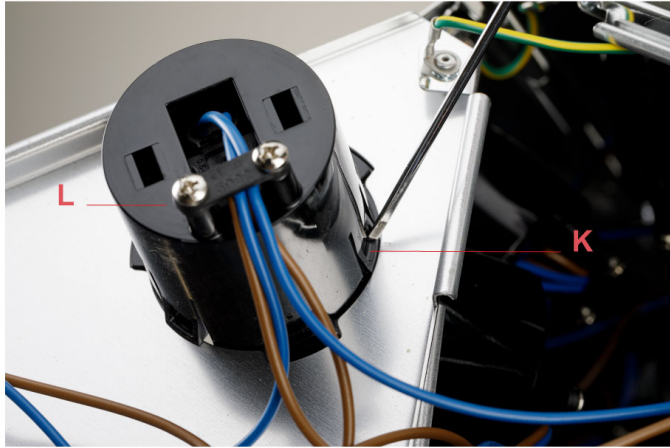

Fig.5

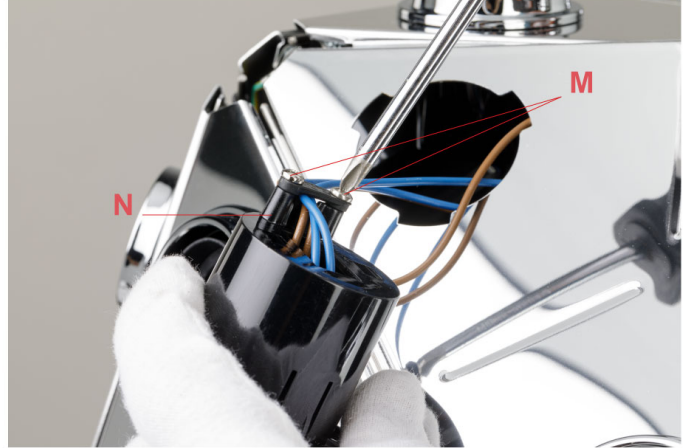

Fig.6

To slide out the ring nut and lamp holder assembly (L) from the triangle it is necessary to press the three fins (K) and push the assembly out.

Remove the cable clamp (N) unfastening the screws (M).

WARNING! When installing and whenever acting on the appliance, ensure that the power supply has been switched off.
For the installation of the spare-part, it is necessary to consult a qualified electrician.

RF03927

E27 Lamp Holder Black

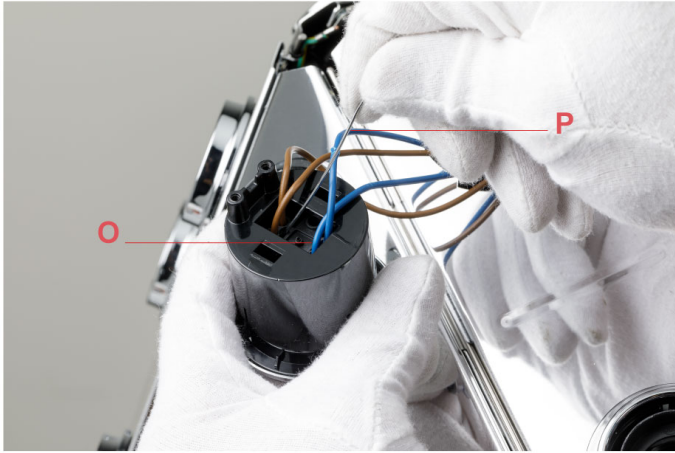

Fig.7



Fig.8

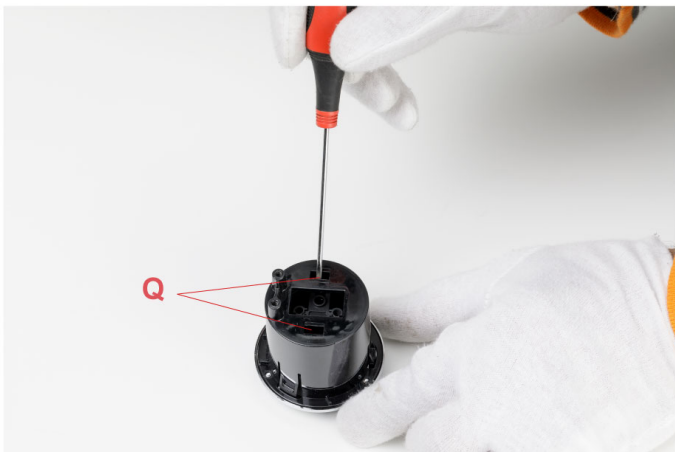

Fig.9

Disconnect the electrical wires (O) from the lamp holder by pressing the push terminals with a paper clip (P).(Fig.7)

To remove the lamp holder (R) from the ring nut (S), it is necessary to push the internal clips (Q) with a flat headed screw driver. (Fig.8-9)

WARNING! When installing and whenever acting on the appliance, ensure that the power supply has been switched off.
For the installation of the spare-part, it is necessary to consult a qualified electrician.

RF03927

E27 Lamp Holder Black



Fig.10



Fig.11

Assemble now the new spare-part:
Insert the lamp holder (R) in the ring nut (S) and lock it through its opposite internal clips (Q).

WARNING! When installing and whenever acting on the appliance, ensure that the power supply has been switched off.
For the installation of the spare-part, it is necessary to consult a qualified electrician.

RF03927

E27 Lamp Holder Black



Fig.12



Fig.13

Connect the electrical wires of the lamp holder. Connect the Brown "L" (live) wires in the terminal that corresponds (opposite side) to the centre brass contact of the lamp holder and then connect the Blue "N" (neutral) wires in the other terminal.

N.B. The electrical wires are connected by pushing the wires inside the terminals, therefore it is necessary to verify that they are connected properly.

Now, reassemble the lamp:

Assemble the cable clamp (N) by fastening the screws (N). (Fig.5 page 10)

Lock back inside the triangle the ring nut and lamp holder assembly (L). (Fig.4 page 9)

Assemble the lamp body (C) on the wall attachment (D) by turning it, as shown in the image on the left hand side.

Settle the lamp body onto wall attachment (D) openings (H).

Fasten the screw (A) of the bell (B) and place it into the lamp body (C). (Fig.1 page 7)

WARNING! When installing and whenever acting on the appliance, ensure that the power supply has been switched off. For the installation of the spare-part, it is necessary to consult a qualified electrician.