

RF3747300

Luce Orizzontale Suspension 2 Led board



WARNING! When installing and whenever acting on the appliance, ensure that the power supply has been switched off.
For the installation of the spare-part, it is necessary to consult a qualified electrician.

RF3747300

Luce Orizzontale Suspension 2 Led board

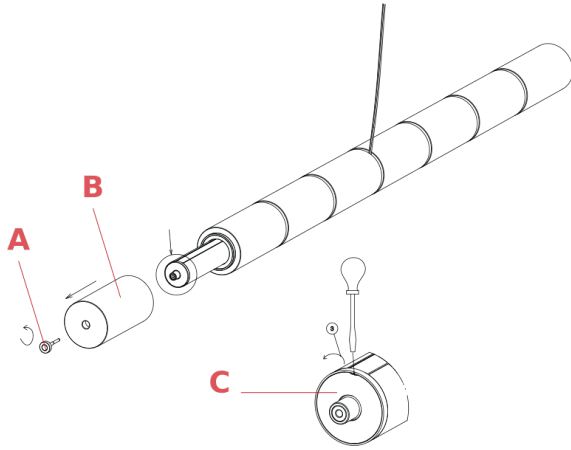

Fig.1

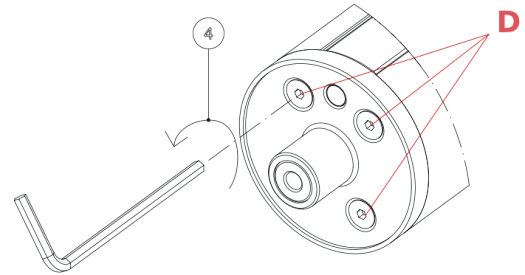

Fig.2

Fig. 1 - unscrew the Touch control command (A) and remove it from the lamp body. Remove the terminal closed glass from the lamp body.

Fig. 2 - Using a flat screwdriver, remove the disc (A). Using an Allen key, unscrew the screws (D).

WARNING! When installing and whenever acting on the appliance, ensure that the power supply has been switched off. For the installation of the spare-part, it is necessary to consult a qualified electrician.

RF3747300

Luce Orizzontale Suspension 2 Led board

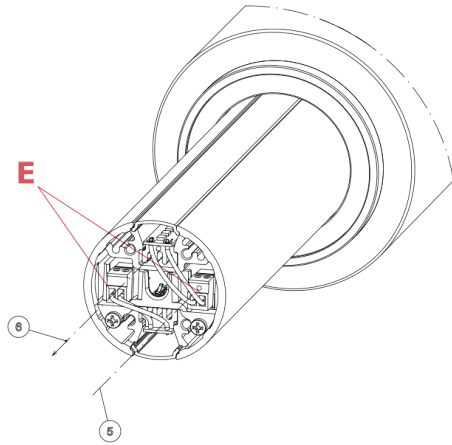

Fig.3a

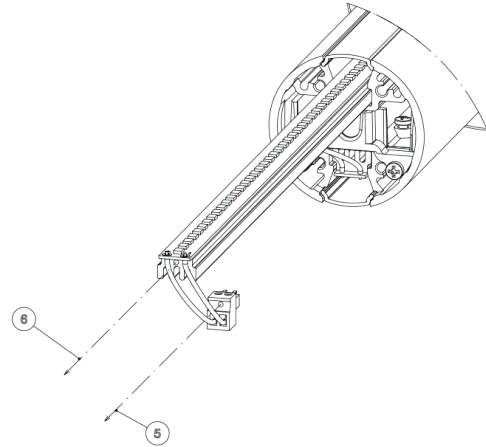

Fig.3b

Fig. 3a - disconnect the terminal of the LED board that we need to replace (E).

Fig. 3b - remove the old LED board to be replaced.

Perform the procedure in reverse to connect the new LED strip.

WARNING! When installing and whenever acting on the appliance, ensure that the power supply has been switched off.
For the installation of the spare-part, it is necessary to consult a qualified electrician.