

F7542031 To-Tie T2

EN

RF7542131

Assembly Body for To-Tie Table 2 Black



WARNING! When installing and whenever acting on the appliance, ensure that the power supply has been switched off. For the installation of the spare-part, it is necessary to consult a qualified electrician.

F7542031 To-Tie T2

EN

RF7542131

Assembly Body for To-Tie Table 2 Black

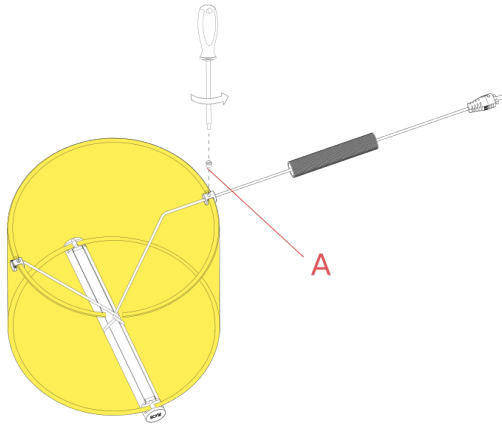

Fig.1

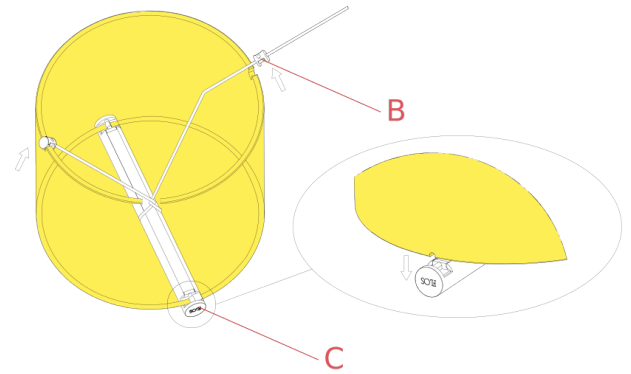

Fig.2

Unfasten the screws (A) using the screwdriver.
Remove the rubber cable clips (B) from the glass diffuser.
Push down the electrical body assembly (C) raising up the glass diffuser.

WARNING! When installing and whenever acting on the appliance, ensure that the power supply has been switched off.
For the installation of the spare-part, it is necessary to consult a qualified electrician.

F7542031 To-Tie T2

EN

RF7542131

Assembly Body for To-Tie Table 2 Black

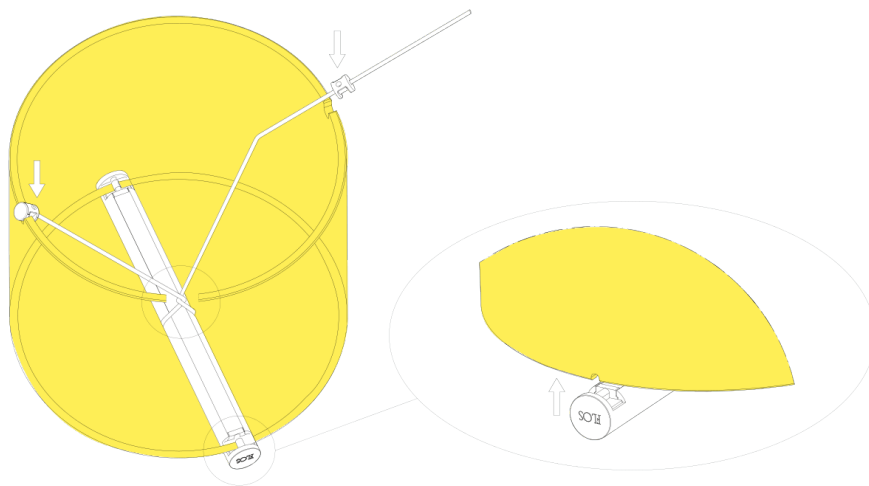

Fig.3

Assemble now the new spare part.
Position the electrical cable as shown in the figure.
Reposition the rubber cable clips in their housing. Connecting the electrical body assembly in the glassdiffuser.

WARNING! When installing and whenever acting on the appliance, ensure that the power supply has been switched off.
For the installation of the spare-part, it is necessary to consult a qualified electrician.

F7542031 To-Tie T2

EN

RF7542131

Assembly Body for To-Tie Table 2 Black

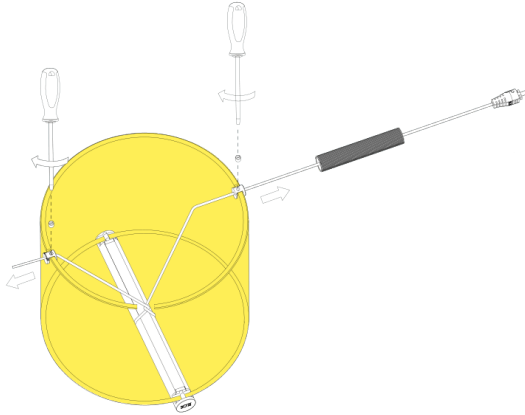

Fig.4

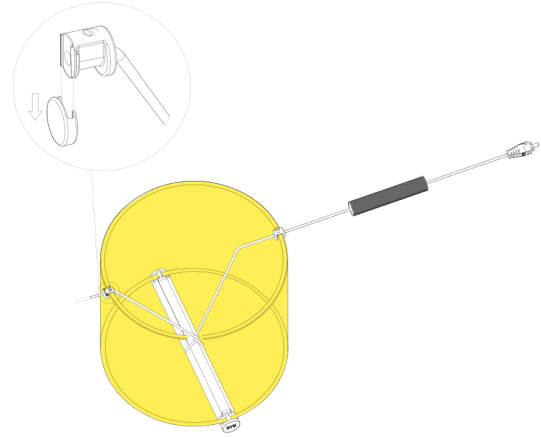

Fig.5

Fix the rubber cable clips to the glass cylinder.
Cut the excess cable and place the closing terminal.

WARNING! When installing and whenever acting on the appliance, ensure that the power supply has been switched off.
For the installation of the spare-part, it is necessary to consult a qualified electrician.