

RF4640300

Ok Steel cable 6mt.



WARNING! When installing and whenever acting on the appliance, ensure that the power supply has been switched off.
For the installation of the spare-part, it is necessary to consult a qualified electrician.

RF4640300

Ok Steel cable 6mt.

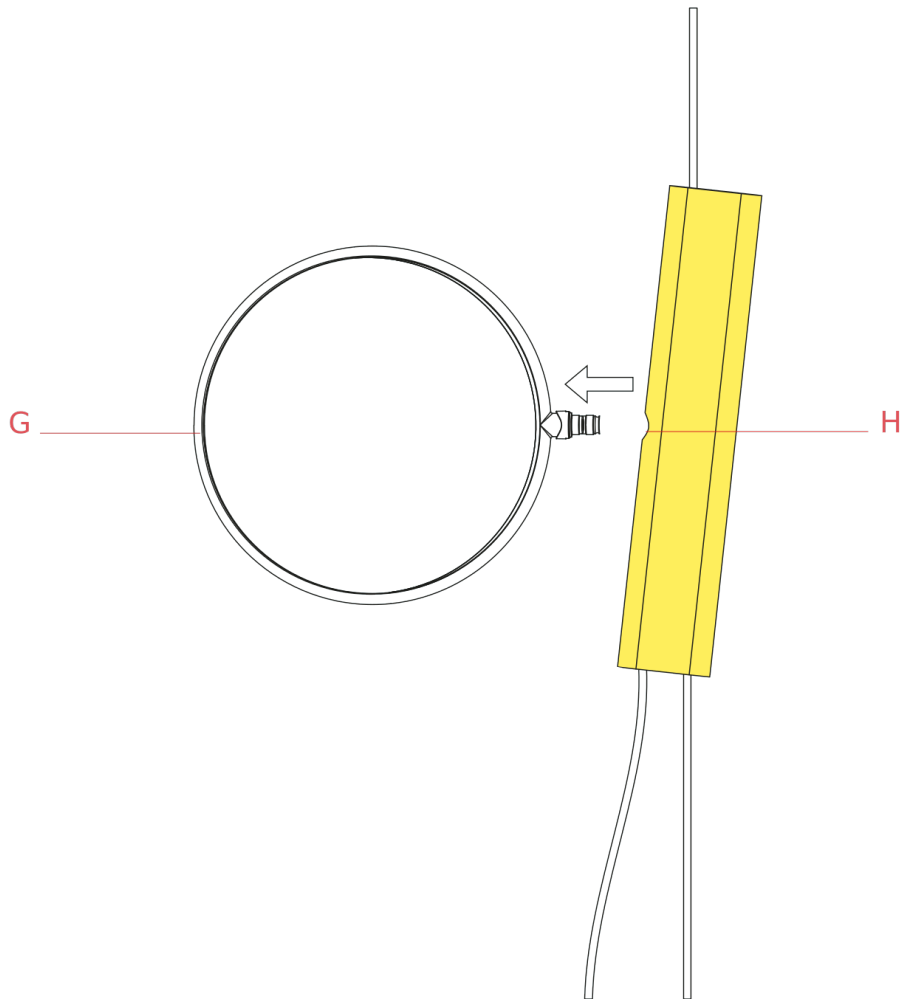

Fig.1

Remove the LED fixture head (G) from the lamp body (H).

WARNING! When installing and whenever acting on the appliance, ensure that the power supply has been switched off.
For the installation of the spare-part, it is necessary to consult a qualified electrician.

RF4640300

Ok Steel cable 6mt.

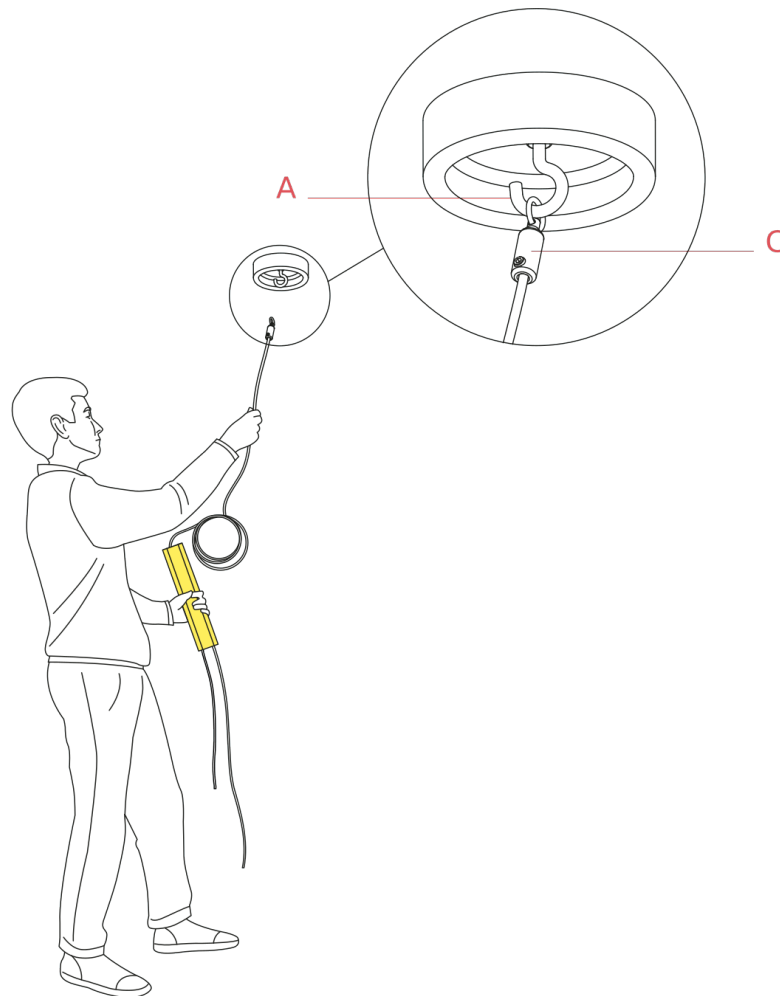

Fig.2

Unhook the steel wire end (C) from the open ring (A).

WARNING! When installing and whenever acting on the appliance, ensure that the power supply has been switched off.
For the installation of the spare-part, it is necessary to consult a qualified electrician.

RF4640300

Ok Steel cable 6mt.

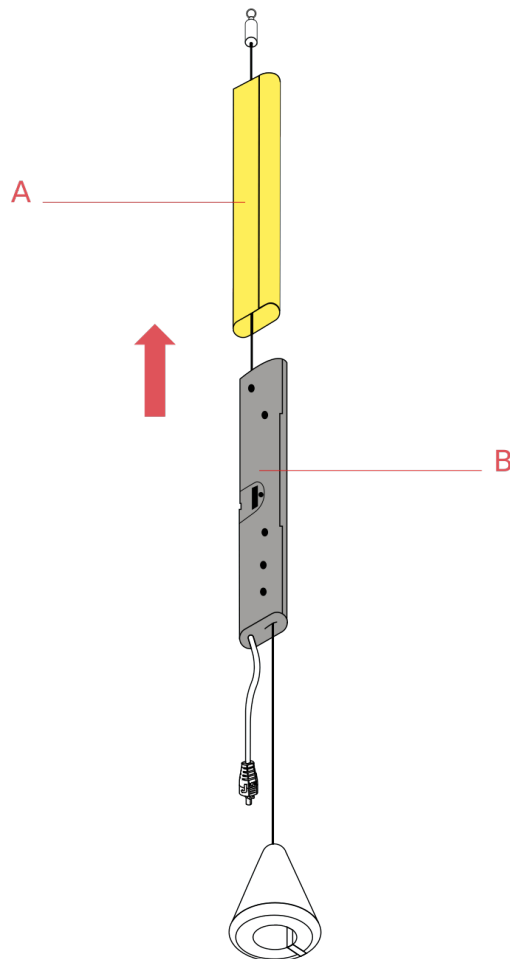

Fig.3

Unlock the damaged extrusion (A) from the central lamp body (B) and slide it off the suspension steel wire.

Assemble now the new spare-part:

Install the new extrusion (A) by sliding it through the suspension steel wire and locking it on the central body (B).

Hook the steel wire end (C) to the open ring (A).(Fig.2 page 2)

WARNING! When installing and whenever acting on the appliance, ensure that the power supply has been switched off.
For the installation of the spare-part, it is necessary to consult a qualified electrician.

RF4640300

Ok Steel cable 6mt.



Fig.4

Remove the cover (B1) from the internal body.

Slide out the steel wire that needs to be replaced starting from the top.

Assemble now the new spare-part:

Install the new steel wire by sliding it through the central body starting from the top as shown in the image (refer to the green line).

Install the new extrusion (A) by sliding it through the suspension steel wire and locking it on the central body (B).(Fig.3 page 3)

Hook the steel wire end (C) to the open ring (A). (Fig.2 page 2)

WARNING! When installing and whenever acting on the appliance, ensure that the power supply has been switched off. For the installation of the spare-part, it is necessary to consult a qualified electrician.

RF4640300

Ok Steel cable 6mt.

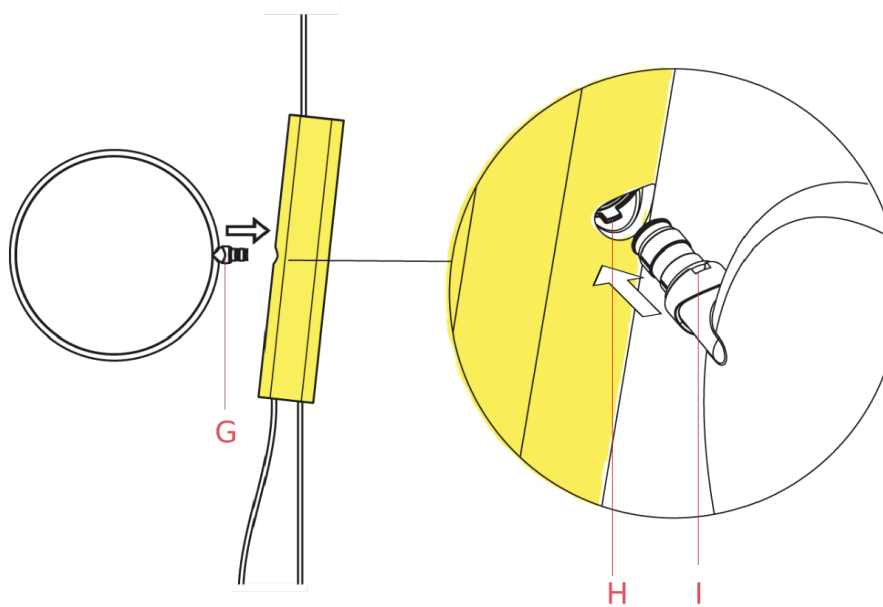

Fig.5

Assemble the LED fixture head, inserting the pin (G) in the hole (H) of the lamp body, ensuring that the guide (I) are correctly oriented (guide "I" needs to be turned upwards).

WARNING! When installing and whenever acting on the appliance, ensure that the power supply has been switched off.
For the installation of the spare-part, it is necessary to consult a qualified electrician.